

Morphology of extraction: Reassessing vP phasehood

Stefan Keine

UCLA

Hedde Zeijlstra

Universität Göttingen

The goal of this paper is to reassess the standard view that (transitive) vPs are phases alongside CPs. We summarize several arguments that document systematic locality asymmetries between CPs and vPs, all of which single out CPs as locality domains but not vPs. These asymmetries receive a principled explanation if CPs are phases but vPs are not. At the same time, the literature has presented a number of strong arguments that vP is a phase alongside CP, which then require reanalysis. We focus particularly on three such arguments: (a) *ké*-morphology in Dinka; (b) *meN*-deletion in Indonesian; and (c) *kè*-morphology in Defaka. These three arguments have been taken as clear evidence that elements that are extracted out of a vP must pass through an intermediate landing site below CP. We propose a reanalysis of these facts that does not appeal to vP phasehood but instead derives the intermediate movement step from the need to leapfrog over an intervening DP. Drawing on recent proposals about the principles that govern the behavior of complex probes, C in these languages can only attract the closest element, requiring leapfrogging for extraction of other elements. Evidence for this shift away from rigid locality domains like vP phases to an intervention account comes from (i) the observation that these morphological effects do not appear with all extraction out of vP and (ii) that these effects may arise in domains higher than vP. We then show that a minimality-based account does not extend to arguments for CP phasehood and we conclude that the most principled explanation for this asymmetry is that CPs are phases but vPs are not.

1. Introduction

According to standard phase theory (Chomsky 2000, 2001, 2008), syntactic structure is subject to periodic Spell-Out (or Transfer), which renders it unavailable for further syntactic processes (the Phase Impenetrability Condition or PIC).¹ This notion of phase does not, in and of itself, determine which domains count as phasal (and equivalently, which heads constitute phase heads). The question is empirical in nature. The traditional view (Chomsky 2000, 2001 and much subsequent work) holds that CPs and (transitive) vPs are phases, at least in the verbal domain, but more recently a number of alternatives has been explored in the literature, including that every phrase is a phase (Bošković 2002, Boeckx 2003, Müller 2004, 2010, 2011, Boeckx and Grohmann 2007; see also Manzini 1994 and Takahashi 1994), that every syntactic operation constitutes a phase (Epstein and Seely 2002), that phasehood is determined contextually

¹ There exist at least two widely adopted versions of the PIC. One is that the phase complement is spelled out once the next-higher head is merged (Chomsky 2000); the other is that Spell-Out takes place when the next-higher *phase* head is merged (Chomsky 2001). We will tentatively assume the former version here but our key claim that vP is not a phase at all is not specifically tied to one choice over the other.

(Bošković 2005, 2014, Den Dikken 2007, Gallego and Uriagereka 2007a,b, Takahashi 2010, 2011), and that CP is a phase but vP is not (Grano and Lasnik 2018, Keine 2020a,b, Poole 2020). Across these proposals, there is broad (though not universal, see Den Dikken 2017) consensus that CP is a phase, a view that goes back to Chomsky (1973, 1977, 1981). But the identity and distribution of other phase heads (e.g., vP, DP, PP) is less securely established and hence more controversial.

In this paper, we focus on the status of vP as a phase. In section 2, we summarize arguments in the recent literature that document various systematic locality asymmetries between CPs and vPs, which remain unexplained if CPs and vPs are on par as locality domains qua phases. Interestingly, all of these asymmetries have in common that CP constitutes a locality domain for a process but vP does not. Attributing phasal status to CP but not vP offers a simple and principled account of this overarching pattern. In the absence of independent, non-phase-related, motivation for these locality differences between CP and vP, these differences therefore raise important questions about the phasality of vP.

But attributing phase status to CPs but not to vP comes with its own challenges. The literature has presented a number of strong arguments that vP is a phase alongside CP (e.g., that both may be the landing site of successive-cyclic movement; see Abels 2012, Citko 2014, Georgi 2014, Van Urk 2020a,c, among others). The crucial question we face, then, is how to reconcile these arguments with the CP–vP asymmetries we observe in other domains. The goal of this paper is to critically examine these arguments and propose that they do not, after all, require vP to be a phase. In section 3, we argue that at least some standard arguments for vP phases are too weak to clearly implicate phasehood because, as a matter of principle, they only show that it is *possible* to move through an intermediate landing site, not that such movement is *obligatory*. This state of affairs can be derived without appeal to phasehood. In section 4–6, we then focus on three arguments that are not subject to this objection: (a) *ké*-morphology in Dinka in section 4; (b) *meN*-deletion in Indonesian in section 5; and (c) *kè*-morphology in Defaka in section 6. All three arguments have been taken as clear evidence that elements that are extracted out of a vP must pass through [Spec,vP], in support of vP phases. We propose a reanalysis of these facts that does not appeal to vP phasehood. While our analyses differ in certain respects across these three case studies, there is an important unifying theme. We agree that these case studies indeed involve an intraclausal intermediate landing site (which, we argue, is not [Spec,vP] in all cases), but we propose that the need for this landing site is not the effect of vP phases. Instead, we adopt the independently motivated idea that C in certain languages may only attract the structurally closest DP (Keenan and Comrie 1977, 1979, Comrie and Keenan 1979, Aldridge 2004, 2008a, Rackowski and Richards 2005, Branam and Erlewine 2020, Coon, Baier and Levin to appear). This restriction has the important consequence that if any DP other than the structurally highest one is to be \bar{A} -moved, it must first move to a position above the highest DP (generally the external argument). Thus, we argue that such movement is not due to vP phasehood but rather due to intervention by a higher DP. The move from vP phases to intervention allows us to understand various otherwise puzzling properties of these effects. First, in Indonesian, the effect arises only with DP extraction, not with PP extraction (a similar, though more limited asymmetry holds in Dinka). The fact that not all moving elements are treated the same favors an intervention account over a phase ac-

count. Second, the Defaka evidence indicates that the location effect is higher than vP. This is problematic for an account in terms of vP phases, and it is more readily amenable to an intervention analysis: if the highest DP is located in TP, then it follows that intermediate movement over this DP target a projection at least as high as TP.

Finally, in section 7 we ask whether an intervention reanalysis of the kind we develop for vP could also be applied to CPs, potentially rendering the concept of phases as a whole unnecessary. We argue that this is not possible because CPs show the relevant locality effects even in the absence of an intervener. Thus, we conclude that CPs are phases (hence Spell-Out domains) but vPs are not, mirroring the CP–vP locality asymmetries just mentioned.

2. Asymmetries between CPs and vPs

Treating vPs as phases alongside CPs leads to the expectation that vPs have the same phase-locality effect as CPs. There is a growing body of evidence that indicates that this is not the case, in that CPs exhibit certain locality effects that vPs (including transitive vPs, i.e., v*Ps) systematically lack. To the extent that these locality effects are the result of phases, such differences cast doubt on the view that CPs and vPs are parallel in their phasal status. In what follows, we provide an overview of these CP–vP locality asymmetries.

Locality of ϕ -agreement: The first difference concerns the locality of ϕ -agreement (Keine 2020b:272–278). This asymmetry is based on a crosslinguistic generalization that Polinsky (2003) and Bobaljik (2008) identify for long-distance agreement (LDA). According to this generalization, LDA may target the edge of an embedded CP clause but not material that is more deeply embedded (see Bruening 2001, Polinsky and Potsdam 2001, Branigan and MacKenzie 2002). This is quite plausibly a CP-phase effect. Once the matrix ϕ -probe enters the structure, only the edge of the embedded clause is accessible, imposing a principled limit on the distance of LDA (see (1)). Keine (2020b) reasons that if vP is a phase, we expect it to likewise limit LDA to its edge. Based on evidence from Hindi-Urdu, Keine (2020b) argues that this is not the case. Instead, we find ϕ -agreement that crosses an arbitrary number of vPs (but still cannot cross a CP), as schematized in (2).

(1) [T_[u ϕ] ... [CP (DP_[ϕ]) [TP ... (DP_[ϕ]) ...]]]

ϕ ----- ϕ
 |-----X-----|

(2) [T_[u ϕ] ... [vP ... [vP ... [vP ... DP_[ϕ] ...]]]]

ϕ ----- ϕ

An example of (2) is provided in (3). LDA is possible here (the slight degradation is due to the center embedding). (3) uses an idiom as in this idiom the embedded object and agreement controller *Pratap-kii khuub marammat* ‘Pratap’s many repairs’ resists movement. Keine (2020b) furthermore argues that the agreement is established between the matrix T and the embedded object directly rather than mediated via the intervening verbs (also see Bhatt 2005) and that the embedded clauses contain vP projections. Because the agreement controller independently resists movement on the idiomatic interpretation, LDA must cross these vP projections.

- (3) ?Ram-ne [_{vP} [_{vP} Pratap-kii khuub **marammat** kar-nii] shuruu kar-nii]
 Ram-ERG Pratap-GEN lot repair.F.SG do-INF.F.SG start do-INF.F.SG
 caah-ii.
 want-PFV.F.SG
 ‘Ram wanted to start giving Pratap a good beating.’ (*lit.* ‘Ram wanted to start doing
 Pratap’s many repairs.’) [Keine 2020b:277, ex. (437)]

The observation that vPs are in principle transparent to ϕ -agreement across them whereas CPs categorically are not poses a clear challenge to the view that vP is a phase alongside CP. If phases constrain ϕ -agreement, then (2) is unexpected. If phases do not constrain ϕ -agreement (e.g., Bošković 2007), then the locality effect in (1) can no longer be attributed to phases and would require a novel locality constraint that only applies to CPs and essentially mimics the properties of phases, an undesirable result. Keine (2020b:278–280) documents the same asymmetry for wh-licensing in Hindi. If CP is a phase but vP is not, such contrasts are precisely what is expected.

Locality of phase-bounded movement: Grano and Lasnik (2018) propose that certain movements cannot proceed successive-cyclically but must proceed in one-fell-swoop (e.g., gapping, QR, *too/enough*-movement). Such movements are therefore phasebounded, and they ordinarily cannot leave a CP (in some cases they can, and Grano and Lasnik 2018 propose that in these configurations CP does not act as a phase). What matters for our concerns here is that such movements are not obstructed by vPs at all. Grano and Lasnik (2018:486–490) conclude that the most principled theory of this asymmetry is one where CP is a phase but vP is not.

Locality of negative concord and NPI licensing: Other dependencies that are subject to syntactic locality exhibit an analogous pattern: they may not cross a CP boundary but they may cross a vP. Examples include negative concord (Zeijlstra 2004, 2012) and licensing of strong NPIs (see Giannakidou and Zeijlstra 2017 and the references therein).

- (4) a. Gianni **non** ha [_{vP} telefonato **a nessuno**].
 Gianni NEG has called to nobody
 ‘Gianni didn’t call anybody.’ [Zeijlstra 2004:130, ex. (50a)]
- b. *Gianni **non** ha detto [_{CP} che ha telefonato **a nessuno**].
 Gianni NEG has said that has called to nobody
 ‘Gianni didn’t say that he called anybody.’ [Zeijlstra 2012:520, ex. (53)]
- (5) a. Mary **didn’t** [_{vP} talk to **any student at all**].
 b. *Mary **didn’t** say [_{CP} that they talked to **any student at all**].

Locality of dependent-case assignment: Poole (2020) argues that dependent-case assignment may not cross a CP but that it may cross a vP. This asymmetry can be derived if CP is a phase, but vP is not (Poole 2020:40–41).

Intermediate gaps in sentence processing: Gibson and Warren (2004) argue that intermediate landing sites created by successive cyclicity facilitate filler retrieval in online sentence processing. Keine (2020a) compares the effect of crossing a CP and of crossing a vP on such facilitation. He finds that while crossing a CP facilitates filler retrieval, crossing a vP does not. He then suggests that this asymmetry receives a principled explanation if CP is a phase (hence requiring an intermediate landing site) but vP is not.

Consequences: All of these patterns involve the same asymmetry between CP and vP: a dependency that is blocked across CPs is not similarly affected by an intervening vP. Importantly, the locality effect of CPs for these dependencies bears the typical properties of phase locality: movement out of CP must proceed through the edge, and in-situ dependencies like agreement are restricted to the CP edge and cannot access lower material. If vP is a phase alongside CP, the question arises why vPs do not have a similar locality effect on these dependencies.²

There are at least two conceivable approaches to this puzzle. The first is to maintain that vP is a phase like CP, but then it must be explained why they differ so strikingly and systematically. We are not aware of any proposals to this effect and it is not obvious to us how this could be achieved in anything but an *ad hoc* way.

The second approach is to conclude that CPs are phases but vPs are not. This approach provides a principled explanation for why vPs lack the phasal locality signature of CPs with respect to the dependencies above, and this is the approach we will explore here. But this line of explanation raises immediate further questions. A rich literature has provided arguments from other empirical domains that vPs do exhibit the locality signature of phases, in particular in that they require extraction out of them to proceed through their edge. If vP is not a phase, these arguments need to be reassessed, and it needs to be shown that the evidence underlying them can be given an analysis that does not rely on vP phases. This is what we set out to do in the remainder of this paper. We focus in detail on three arguments, all of which are based on morphological reflexes of movement across vP: (a) *ké*-morphology in Dinka, (b) *meN*-deletion in Indonesian, and (c) *kè*-morphology in Defaka. We propose alternative analyses of these phenomena that do not involve vP phases, thereby reconciling this body of evidence with the claim that vP is not a phase and hence brings it in line with the CP–vP asymmetries just discussed.

3. Optional vs. obligatory movement through [Spec,vP]

Before we turn to the three core case studies of this paper, we briefly motivate why we focus on morphological reflexes of successive cyclicity. While the literature contains a substantial number of arguments for vP phases, the arguments from morphological reflexes seem to us to be particularly compelling. As Keine (2020b) points out, other arguments are less convincing because they involve an *optional* phenomenon. Keine makes this case on the basis of recon-

² Note that assuming that not every syntactic dependency is sensitive to phasality (e.g., by assuming that only movement, but not agreement is sensitive to the Phase Impenetrability Condition; see Bošković 2007) would not solve this problem because this view still predicts CPs and vPs to pattern alike for each type of dependency. If a dependency is subject to phase locality, it should exhibit the effect at CP and vP; on the other hand, if a dependency is not subject to phase locality, it should not exhibit it at either CP or vP. This is not the case for the asymmetries just discussed.

struction and parasitic gaps, to which we add quantifier float. In a nutshell, these phenomena establish that it is *possible* for a movement to pass through an intermediate landing site in the vP region, but not *necessary*. While this is compatible with vP phases, it does not in and of itself require vP phases and as such it does not constitute direct evidence that vP is a phase.

The argument from reconstruction is due to Fox (1999), Legate (2003), and Sauerland (2003) (also see Agüero-Bautista 2001) and involves configurations like (6). In this example, the \bar{A} -moved DP contains (i) the pronoun *he*, which is bound by *every student* and (ii) the R-expression *Ms. Brown*, which is coindexed with the pronoun *her*. Fox (1999) reasons that the moved constituent cannot be interpreted in either its base position or its surface position. This is because in the base position, the R-expression *Ms. Brown* is c-commanded by *her*, which would violate Condition C. In the surface position, *he* is not c-commanded by *every student*, which is incompatible with the bound reading of the pronouns. Fox concludes that the moved DP must be interpreted in an intermediate position that is located lower than *he* (to allow binding) but higher than *Ms. Brown* (to escape Condition C). Fox identifies this position as [Spec,vP]. (6) then shows that it is possible for an \bar{A} -moved element to create an intermediate landing site at vP.

- (6) [Which of the books that **he**₁ asked **Ms. Brown**₂ for] did **every student**₁ ___ get from **her**₂ ___* ? [Fox 1999:174, ex. (40a)]

While this analysis is clearly compatible with vP phases, the crucial question is whether it *requires* vP phases. Keine (2020b) argues that it does not. The availability of the relevant reading in (6) provides evidence that it is *possible* for the moved element to reconstruct into an intermediate position. This is compatible with two different analyses. One is that the element *must* pass through the intermediate position; the other is that the element *may* (but need not) pass through this position. Postulating vP phases commits one to the former, but the example and analysis in (6) in fact underdetermine the choice. To develop the latter option, one might assume that the intermediate landing site is simply a different movement type that optionally applies. For example, Grohmann (1997), Wiltschko (1997), Fanselow (2004), and others provide evidence that wh-movement in German may optionally be preceded by a scrambling/QR step (see also Takahashi 1993 for Japanese). For English, Kotek (2014, 2019) and Poole (2017) argue that wh-movement may be preceded by a covert scrambling step, which also instantiates QR and which is unrelated to phasehood.³

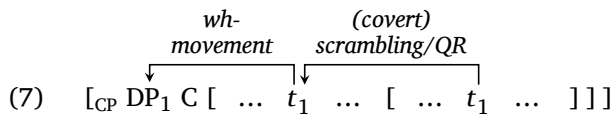

As long as one movement type may apply to the output of another, the derivation in (7) is allowed regardless of whether vP is a phase or not. The intermediate landing site that is implicated in the arguments from reconstruction can then be analyzed as the landing site of the scrambling step in (7), without appeal to vP phases. While the intermediate movement step in

³ Legate (2003) argues based on Antecedent-Contained Deletion that QR may target both agentive and nonagentive vP in English. Legate concludes from this that both types of vP are a phases. But like the argument from reconstruction, this argument only demonstrates that vPs provide a possible landing site for QR, not an obligatory one, and as such it does not require vP to be phase, as far as we can tell.

(7) is then optional, the fact that it is possible is sufficient to account for (6). One implication of this alternative analysis is that such intermediate landing sites should not be limited to [Spec,vP]. This seems correct. Fox (1999:175n32) notes that it is possible to use the reconstruction evidence to diagnose an intermediate landing site in every maximal projection. This seems to us to be an argument against a phase-based account of the reconstruction facts, at least unless one treats all phrases as phases, in which case the phase–nonphase distinction collapses. By contrast, if the intermediate landing site—rather than being tied to phasehood—is created by optional QR with a flexible landing site, as we have proposed, then the variability in the location into which reconstruction takes place receives an immediate explanation.

Other purported arguments for vP phases are subject to the same objection, for example arguments based on parasitic gaps (Nissenbaum 2000:48–53, Legate 2003:510–511, Abels 2012:43–47). These arguments are based on Nissenbaum’s (2000) account of parasitic gaps, which requires an intermediate landing site in [Spec,vP]. On this account, the possibility of parasitic gaps again establishes that it is *possible* for an \bar{A} -moved object to pass through an intermediate landing site, but it does not establish that such a landing site is *obligatory*.

A third argument of this type is based on quantifier float in varieties of West Ulster English (McCloskey 2000, Henry 2012). Many of these varieties allow floating of *all* in a greater set of environments than standard English, including at the vP edge, as Henry (2012) shows. (8) provides an example from East Derry English.

(8) What₁ did he [_{vP} **all** do ___₁ in Derry]? [Henry 2012:31, ex. (52)]

At least on a stranding analysis of quantifier float (Sportiche 1988, Bošković 2004; though see Bobaljik 2003 for critical discussion), (8) demonstrates that it is possible for the \bar{A} -moved element to move through a [Spec,vP] and strand *all* there. As before, because quantifier float is optional, these facts are equally compatible with the alternative analysis in (7).

We conclude, therefore, that these arguments are too weak to unambiguously establish the need for vP phases. In general, any argument that involves an *optional* reflex of an intermediate landing site is subject to this criticism, and we will therefore put arguments of this type aside. We will focus instead on arguments that involve an obligatory reflex, as such arguments cannot be reanalyzed in this way and are therefore stronger. The most common class of arguments that meets this requirement involve obligatory morphological reflexes that obligatorily appear along the movement path.⁴ The next three sections discuss three such arguments.

⁴ A second property shared by the three case studies we discuss is that there is a subject–object asymmetry in that object extraction causes the reflex but local subject extraction does not. This asymmetry is often the key motivation for locating the effect at vP and hence for analyzing the pattern in terms of vP phases. There are also arguments for vP phases based on patterns where extraction of both subjects and objects shows a morphological reflex. In general, such arguments are considerably weaker evidence for vP phases because the lack of a subject–object asymmetry means that it is not clear that vP is the relevant domain. To illustrate, in Passamaquoddy, a verb that is crossed by \bar{A} -movement optionally appears in an agreeing participial form (Bruening 2001, 2004). Van Urk (2016, 2020a,c) considers this pattern an argument for vP phases. The key property of a phase is that it distinguishes elements in the specifier from elements in the complement. If elements in [Spec,vP] behave the same as elements inside VP with respect to an effect, as is the case in Passamaquoddy, then this effect does not itself provide clear evidence that vP is a phase. Nor does the fact that an alternation surfaces on the verb implicate vP phasehood. Ever since Chomsky’s (1957) seminal analysis of affix hopping, it is virtually universally accepted that English tense and agreement have a high syntactic location (either T or even C; see Chomsky 2007, 2008) despite the fact that the corresponding surface morphology appears on the verb. Any theory that encompasses affix hopping, feature lowering, or some equivalent device to handle English may thus account for Passamaquoddy in the same way—an \bar{A} -moved element agrees with a structurally high head (perhaps C), and this agreement is morphologically realized on the verb, with no involvement of vP or VP phases.

4. Dinka ké-morphology

One of the strongest and most well-developed arguments for successive cyclicity through [Spec,vP] and vP phasehood is developed for the Nilotic language Dinka by [Van Urk \(2015, 2018\)](#) and [Van Urk and Richards \(2015\)](#). The argument is two-pronged. First, extraction has an empty-position effect within the vP; second, such extraction leads to the appearance of the special marker *ké* in the vP region. The two aspects of the argument are interrelated, and we will present them in turn.

4.1. Empirical evidence

4.1.1. V2 effects

As illustrated in (9), Dinka is a V2 language, with exactly one constituent preceding a verbal element in the second position of the clause.

- (9) a. Àyén à-**càm** cuḷin nè pǎal.
Ayen 3P-eat food P knife
'Ayen is eating food with a knife.'
- b. Cuḷin à-**céem** Áyèn nè pǎal.
food 3P-eat.OV Ayen.GEN P knife
'Food, Ayen is eating with the knife.'
- c. Pǎal à-**céemè** Áyèn cuḷin.
knife 3P-eat.OBLV Ayen.GEN food
'With a knife, Ayen is eating food.'

[[Van Urk 2018:942](#), ex. (6a–c)]

Turning to the Dinka vP, [Van Urk \(2015, 2018\)](#) and [Van Urk and Richards \(2015\)](#) argue that here too we find a V2 property such that exactly one constituent precedes the verb in the vP. For example, in a transitive clause, the object must occur in a preverbal position, as shown in (10).

Another recent argument that involves an effect that does not discriminate between subject and objects is presented by [Korsah and Murphy \(2020\)](#) based on tonal reflexes in Asante Twi. Again, due to the lack of a subject–object asymmetry, it does not seem necessary to appeal to vP phases here. In fact, [Korsah and Murphy \(2020\)](#) provide evidence that the syntactic locus of the effect is (i) higher than the base position of the external argument, (ii) higher than adjunct PPs, (iii) higher than negation, and (iv) higher than progressive and perfective aspect. Taking all of these generalizations together, there is clear convergence that the syntactic locus of the effect is structurally quite high. As in the case of Passamaquoddy, the fact that the effect nevertheless surfaces on the verb may be attributed to standard morphological lowering operations. We note that [Korsah and Murphy \(2020\)](#) do argue that the effect is not as high as C. Their argument is based on the generalization that the verb, negative prefix, and aspect undergo the tone shift, but tense suffixes and agreement prefixes do not. [Korsah and Murphy \(2020\)](#) conclude from this that the locus of the effect must be lower than tense and agreement. However, contra to [Korsah and Murphy's \(2020\)](#) generalization, [Marfo \(2005a, 2005b:164–166\)](#) shows that the tone shift does spread onto agreement prefixes under the right circumstances and that the cases in which the tone does not spread is phonologically conditioned (the tone cannot spread across an onset). As far as we can tell, this purely phonological account covers [Korsah and Murphy's \(2020\)](#) cases, and so no appeal to vP phases is necessary to account for them.

In sum, arguments that do not exhibit a subject–object asymmetry are at most weak evidence for vP phases because the locus of the effect can easily be located in a domain other than vP. We therefore focus on arguments in which subject and object extraction shows a different morphological signature.

- (10) a. $\Upsilon\acute{\epsilon}\epsilon\text{n}$ $\text{c}\acute{\epsilon}$ mìir $\text{t}\grave{\eta}$.
 I PFV giraffe see
 ‘I saw a giraffe.’
- b. * $\Upsilon\acute{\epsilon}\epsilon\text{n}$ $\text{c}\acute{\epsilon}$ ____ $\text{t}\grave{\eta}$ mìir.
 I PFV see giraffe
 ‘I saw a giraffe.’ [Van Urk and Richards 2015:122, ex. (14a,b)]

If the vP is ditransitive, one of the two objects must occupy the preverbal position, as (11a–b) illustrates. It is not possible for both objects to occur postverbally (11c–d), nor is it possible for both objects to occur preverbally (11e–f).

- (11) a. $\Upsilon\acute{\epsilon}\epsilon\text{n}$ $\text{c}\acute{\epsilon}$ Ayén yièn kìtáp.
 I PFV Ayen give book
- b. $\Upsilon\acute{\epsilon}\epsilon\text{n}$ $\text{c}\acute{\epsilon}$ kìtáp yièn Ayén.
 I PFV book give Ayen [Van Urk and Richards 2015:122, ex. (15a,b)]
- c. * $\Upsilon\acute{\epsilon}\epsilon\text{n}$ $\text{c}\acute{\epsilon}$ ____ yièn kìtáp Ayén.
 I PFV give book Ayen
- d. * $\Upsilon\acute{\epsilon}\epsilon\text{n}$ $\text{c}\acute{\epsilon}$ ____ yièn Ayén kìtáp.
 I PFV give Ayen book [Van Urk and Richards 2015:122–123, ex. (16a,b)]
- e. * $\Upsilon\acute{\epsilon}\epsilon\text{n}$ $\text{c}\acute{\epsilon}$ kìtáp Ayén yièn.
 I PFV book Ayen give
- f. * $\Upsilon\acute{\epsilon}\epsilon\text{n}$ $\text{c}\acute{\epsilon}$ Ayén kìtáp yièn.
 I PFV Ayen book give
 ‘I gave Ayen a book.’ [Van Urk and Richards 2015:122n11, ex. (i.a,b)]

If there is no object, the preverbal position remains empty. Adjuncts cannot occupy this position and must appear postverbally, as in (12).

- (12) a. $\text{W}\acute{\omicron}\text{k}$ $\text{c}\acute{\epsilon}$ ____ kêet dòm-íc.
 we PFV sing garden-in
 ‘We sang in the garden.’
- b. * $\text{W}\acute{\omicron}\text{k}$ $\text{c}\acute{\epsilon}$ dòm-íc kêet.
 we PFV garden-in sing
 ‘We sang in the garden.’ [Van Urk and Richards 2015:123, ex. (17a,b)]

Van Urk (2015, 2018) and Van Urk and Richards (2015) analyze this preverbal position as [Spec,vP], though we will diverge from this view in our own analysis.

If there is a movement dependency, every [Spec,CP] and preverbal position along the movement path must be empty. This is shown for [Spec,CP] in (13) and for the preverbal position in (14). As (14a) shows, it is possible for movement to target the preverbal object in a ditransitive configuration (whether it is a direct or indirect object). By contrast, (14b) shows that it is not possible to move the postverbal DP.

- (13) a. Yeṅà cǐkkù luéel, [_{CP} ____ cé kítáp ɣ̀̀̀̀c]?
 who PFV.1PL say PFV book buy.TR
 ‘Who did we say bought a book?’
- b. *Yeṅà cǐkkù luéel, [_{CP} kítáp (à-)cǐ ɣ̀̀̀̀c]?
 who PFV.1PL say book (3SG-)PFV.NSV buy.TR
 ‘Who did we say bought a book?’ [Van Urk and Richards 2015:125, ex. (21a,b)]
- (14) a. Yeṅà cǐ m̀̀c ____ yiṅ kítáp?
 who PFV.NSV man.GEN give book
- b. *Yeṅà cǐ m̀̀c kítáp yiṅ?
 who PFV.NSV man.GEN book give
 ‘Who did the man give the book to?’ [Van Urk and Richards 2015:125, ex. (20a,b)]

Van Urk (2015, 2018) and Van Urk and Richards (2015) analyze both effects in terms of phases. (13) follows from CP phases. And based on the analysis of the preverbal position as [Spec,vP], (14) is attributed to vP phases: only an object that has shifted to [Spec,vP] is accessible for further movement to [Spec,CP]. One-fell-swoop extraction as would be necessary in (14b) is therefore ruled out.⁵

4.1.2. *Ké-stranding*

As investigated in detail by Van Urk (2015), Van Urk and Richards (2015), and in particular Van Urk (2018), in addition to this empty-position effect, \bar{A} -extraction out of vP in Dinka yields special morphology, as we now discuss. Whenever a plural element is moved out of vP in Dinka except for local subjects, the element *ké* (or *kêek*) must appear next to every verb that is crossed by the movement. This element is homophonous with (and, depending on the analysis, identical to) the 3rd person plural personal pronoun. The appearance of *ké* is illustrated in (15), where \bar{A} -movement of *yeyíṅà* ‘who.PL’ and *kêek* ‘them’ requires a preverbal *ké*, which is impossible in the absence of such movement.

- (15) *Object \bar{A} -movement triggers ké*
- a. **Yeyíṅà** cǐ B̀̀l **ké** t̩ṅ?
 who.PL PFV.NSV Bol.GEN PL see
 ‘Who all did Bol see?’ [Van Urk and Richards 2015:127, ex. (23b)]
- b. **Kêek** áa-cǐ Áyèn **ké** t̩ṅ.
 them 3PL-PFV.OV Ayen.GEN PL see.NF
 ‘Them, Ayen has seen.’ [Van Urk 2018:947, ex. (19c)]

The marker *ké* is restricted to the vP region—it cannot appear in C or [Spec,CP]. Furthermore, *ké* is ϕ -sensitive in that it only appears if the moving element is plural, as (16) demonstrates, where the corresponding 3SG element *yé(en)* may no occur and *ké* would also be ungrammatical.

⁵ Note that this analysis requires that *yeyà* ‘who’ in (14b) cannot pass through a second [Spec,vP] on its way to [Spec,CP], a restriction that the theory in Van Urk (2015) and Van Urk and Richards (2015) derives.

4.2. vP-phase account

In a nutshell, [Van Urk \(2015, 2018\)](#) and [Van Urk and Richards \(2015\)](#) propose that *ké* is the realization of an intermediate copy in [Spec,vP], and given that *ké* is obligatory, they conclude that vP must therefore be a phase. Abstracting away from the details of the implementation, they treat the preverbal object position as [Spec,vP], as already mentioned. Because *v* has an EPP requirement, this position must be filled if an object exists. Due to vP's phasehood, an element that is to be moved out of the vP must first move to this [Spec,vP], from where it can then continue to move to [Spec,CP].⁶ If it is plural, this intermediate copy in [Spec,vP] is then realized as *ké*. Because of vP's phasehood, movement through [Spec,vP]—and hence *ké*—is required in every clause crossed by movement.

This account is elegant and insightful. The argument also meets the requirements put forth in section 3 because both reflexes (emptying of the preverbal position and emergence of *ké*) are obligatory. It therefore constitutes strong evidence for obligatory successive cyclicity, and vP phases provide a principled account. At the same time, the account faces a number of challenges. The first complication is that \bar{A} -extraction of a local external argument does not lead to *ké* (see (18)). All else being equal, this is surprising given that external arguments are typically taken to be base-generated in [Spec,vP]. As a consequence, they too should leave a copy in [Spec,vP], which we would then expect to be realized as *ké*, contrary to fact. [Van Urk \(2018:943n5\)](#) briefly discusses this challenge and suggests two possible analyses. One is that the external argument is not actually base-generated in [Spec,vP], but in a higher specifier. In this case, it is no longer evident that the Dinka data provide evidence for vP phases, at least if by “vP” we mean the projection that generates the external argument, as is standard. The other analysis suggested by [Van Urk](#) is that only copies of elements that appear in [Spec,vP] as a result of attraction by (i.e., Agree with) *v* are realized as *ké*. This analysis raises the question how the morphological realization of a copy in [Spec,vP] can be conditioned by whether Merge of this copy was the result of attraction by *v* or not. If *v* selects the external argument, then there is some relation between *v* and the external argument as well, which raises the question why this relation is not sufficient to license *ké*. Furthermore, if Move is an instance of Merge ([Starke 2001](#), [Chomsky 2004](#)), then the necessary distinction between elements moved to [Spec,vP] and elements base-generated there cannot be drawn with respect to Merge either. While these complications are probably surmountable, it is clear that resolving them increases the complexity of the account. What is most significant for our purposes here is that the asymmetry between subjects and objects (with only objects leading to *ké*) does not follow from the vP-phase account as such but requires additional assumptions. In other domains (such as the Indonesian and Defaka data discussed in sections 5 and 6, also see fn. 4), the existence of a subject–object asymmetry is the key motivation for invoking vP phases, but at least in Dinka, this asymmetry itself does not seem to directly implicate vP phases.

A second complication concerns the status of unaccusative vP. In Dinka, \bar{A} -extraction of an internal argument of an unaccusative verb does not lead to *ké*, as shown in (21), where movement of *pěēel-kó* ‘which knives’ does not leave a *ké*.

⁶ Though see [Keine \(2020b:283–288\)](#) for some critical discussion of the role of vP phasehood in this account. [Keine](#) argues that the intermediate landing site in [Spec,vP] is already required by *v*'s EPP requirement and that additional appeal to vP phasehood does not make a substantive contribution to [Van Urk and Richards's \(2015\)](#) and [Van Urk's \(2015\)](#) account. Here we develop a much more significant reanalysis of the Dinka facts.

(21) *Argument movement out of unaccusative vP does not strand ké*

Yè [CP **pě̀el-kó** bẹ̀ [vP (***ké**) dhuòŋ]]?
 be knives-which FUT (*PL) break.NF

‘Which knives will break?’

[Coppe van Urk, p.c.]

At first glance, this restriction might be taken to indicate that unaccusative vP is not a phase and hence that there is no intermediate copy in [Spec,vP] (Chomsky 2000, 2001). However, \bar{A} -extraction of a PP adjunct out of such vPs does lead to *ké*, as (22) demonstrates, where movement of *thè̀ek-kó* ‘at which times’ strands *ké*.

(22) *PP-adjunct movement out of unaccusative vP strands ké*

Yè [CP **thè̀ek-kó** bẹ̀i pè̀el [vP **ké** dhuòŋ]]?
 be times-which FUT.OV knives PL break.NF

‘At which times will the knives break?’

[Van Urk 2015:168, ex. (81)]

On the face of it, the distribution of *ké* indicates that arguments of unaccusatives must exit vP in one-fell-swoop whereas adjuncts must do so successive-cyclically. vP phases themselves do not account for this difference.⁷

In fact the absence of *ké* in (21) poses a problem for the analysis of why external arguments do not trigger *ké*. As just discussed, Van Urk (2018) sketches two possible approaches to the latter generalization: either (i) the external argument is generated outside of vP or (ii) only copies in [Spec,vP] that are the result of *movement* are realized as *ké*. Neither account generalizes to the fact that unaccusative subjects also do not strand *ké* because they are clearly generated vP-internally and move to [Spec,vP]. Further stipulations are therefore necessary to derive the full distribution of *ké*.

A third challenge for this account is that *ké* only realizes intermediate copies in [Spec,vP], not intermediate copies in [Spec,CP]. All else being equal, if both CP and vP are phases and intermediate landing sites are created in their respective specifiers, then additional assumptions are again required to prevent the two domains from patterning analogously (Van Urk 2018:975–976 appeals to impoverishment in CP). This is certainly feasible, but it raises the question why there seem to be no languages that realize lower copies in both CP and vP. If vP is a phase in the same way that CP is, we might expect this to be the default pattern, and yet it appears to be unattested. As a result, a vP-phase account thus requires additional stipulations to break the purported symmetry in the two domains.⁸

⁷ Moreover, the criterion that phases are propositional units (Chomsky 2000:107, Chomsky 2001:12) does not differentiate between agentive and unaccusative vPs as both are θ -complete. Chomsky (2001) thus proposes that unaccusative vP is a “weak” phase, which does not induce PIC effects. This distinction between “weak” v and “strong” v does not follow from anything else. Thus, if the absence of *ké* in (22) is attributed to vP being weak here, this is itself a stipulation, and furthermore one that seems to have no counterpart in the CP phase. As we will see, the shift from vP phases to minimality will allow us to dispense with the strong/weak distinction for phases, thereby eliminating the stipulation.

⁸ Van Urk (2018:976) acknowledges the expectation of finding languages with stranding in both [Spec,CP] and [Spec,vP], but he assumes that copy realization is limited to positions that are created by independent EPP/V2 property (based on treating the EPP as a PF constraint, see Richards 2001, 2016 and Landau 2007). As a result, double copy realization would only arise in language in which both CP and vP exhibit a V2 pattern. This assumption does not preclude *ké* in both [Spec,CP] and [Spec,vP] in Dinka (both of which show V2 behavior), but it does address the apparent crosslinguistic absence of such symmetrical copy-realization patterns. We nonetheless would like to note that this assumption is not unproblematic. This is because other cases of lower-copy realization exhibit the exact op-

4.3. Proposal: *ké* and leapfrogging

Because Van Urk’s (2015, 2018) and Van Urk and Richards’s (2015) argument for vP phases in Dinka involves (a) an empty-edge effect in the vP (section 4.1.1) and (b) *ké*-morphology (section 4.1.2), our alternative analysis will need to address both.

We first consider the obligatory emergence of *ké* under \bar{A} -extraction if the object of a transitive clause is moved. We broadly agree with analyzing *ké* as a reflex of successive-cyclic movement. Where we differ from Van Urk (2015, 2018) and Van Urk and Richards (2015) is in whether this successive cyclicity is to be analyzed in terms of vP phases. Doing so faces the challenges just mentioned and more generally calls for an explanation of the various CP–vP asymmetries discussed in section 2. Instead, we explore an account of the Dinka pattern that does without vP phases. We propose that the successive cyclicity that *ké* is a reflex of is instead caused by the restriction in (23).

(23) Dinka C may only attract the structurally closest DP.

The restriction in (23) underlies not only our account of Dinka, but also the accounts of Indonesian and Defaka. In a nutshell, what (23) expresses is a minimality/intervention effect. Because C can only attract the structurally closest DP, any DP that is separated from C by a higher DP cannot be attracted, as schematized in (24a). We suggest that this gives rise to the need for “leapfrogging” (a term due to McGinnis 1998): the lower DP must first move to a position above the higher DP, from which it is then the closest goal to C, enabling movement to [Spec,CP] that conforms with (23), as shown in (24b).

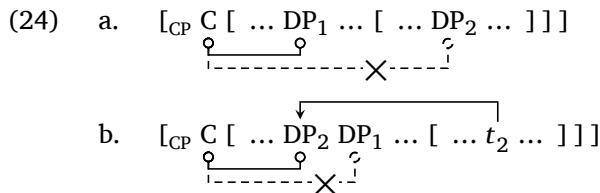

The key difference between vP phases and (23) is that it is an intervening DP, rather than the vP, that gives rise to the locality effect. Often, the two coincide, namely if the highest DP is the external argument in [Spec,vP]. In other configurations the two accounts come apart, as we show below.

Restrictions like (23) have been proposed independently in the recent literature, and they may be implemented in a number of ways. Aldridge (2004, 2008a) proposes a restriction like

posite pattern. In German, for instance, it is possible to pronounce a lower copy of a simple wh-element in [Spec,CP] of a V-final clause (i.a), but not in [Spec,CP] of a V2 clause (i.b), see Höhle (2000).

- (i) a. **Wen₁** hat Maria gesagt [_{CP} **wen₁**/dass die Susi ₁ gesehen hätte]?
 who.ACC has Maria said who.ACC/that the Susi.NOM seen had V-final clause
 ‘Who did Mary say that Susi had seen?’
- b. **Wen₁** hat Maria gesagt [_{CP} (***wen₁**) hätte die Susi ₁ gesehen]?
 who.ACC has Maria said (*who.ACC) had the Susi.NOM seen V2 clause
 ‘Who did Maria say that Susi had seen?’

This is despite the fact that V2 clauses have an EPP property but V-final clauses do not (that is, [Spec,CP] is obligatorily filled in V2 clauses but not in V-final clauses). This pattern conflicts with Van Urk’s (2018) account of the crosslinguistic absence or rarity of copy realization in both vP and CP.

(23) to account for \bar{A} -extraction restrictions in certain ergative languages. Analogous restrictions are proposed and argued for by [Erlewine \(2018\)](#), [Branan and Erlewine \(2020\)](#), and [Coon et al. \(to appear\)](#). We therefore take (23) to be independently motivated. Our goal is to further broaden its scope by assimilating apparent vP-phase effects to this restriction instead.

How might we think of (23) on an implementational level? The literature just cited has offered various suggestions. For the sake of concreteness, we will adopt for Dinka what seems like the simplest implementation. Because Dinka is a V2 language, we assume that C bears an EPP property that is nondiscriminating—it does not search for elements with a specific \bar{A} -feature but is instead matched by any DP. (23) then follows from C attracting the closest possible goal. As such, (23) is simply an instance of relativized minimality ([Rizzi 1990](#)) in Dinka. Other implementations are conceivable and fully compatible with what is to come ([Erlewine 2018](#), [Branan and Erlewine 2020](#), [Coon et al. to appear](#)); also see sections 5 and 6.

At first glance, (23) appears empirically incorrect. Clearly, it is possible for elements other than the local subject (which is structurally closest to C) to occupy [Spec,CP]. But it is precisely in such cases that *ké* must appear, which suggests that the two are connected. We propose that such cases involve “leapfrogging”: the lower DP first moves across the external argument, from which it can then be attracted by C, as in (24b). We then analyze *ké* as the reflex of the probe that gives rise to this leapfrogging. For the sake of concreteness, we will assume that external arguments do not have to raise to [Spec,TP] in Dinka (see [Cable 2012](#) for arguments that the related Nilotic language Dholuo does not show EPP effects in T). Leapfrogging must therefore move a DP across the external argument in [Spec,vP]. We propose that this leapfrogging is triggered by *v*, which optionally bears a strong φ -Agree feature [*u* φ]. If it is present, [*u* φ] agrees with the closest φ -bearing element c-commanded by *v* and attracts this element to an outer [Spec,vP], a position above the base position of the external argument, resulting in leapfrogging. Because *ké* only appears if the moving element is plural, we take it to be the realization of plural agreement with [*u* φ], as stated in (25).

(25) /*ké*/ ↔ [PL]

In contrast to [Van Urk \(2015, 2018\)](#) and [Van Urk and Richards \(2015\)](#), we hence do not analyze *ké* as the realization of an intermediate copy, but rather as agreement on *v*.⁹

The gist of this analysis is thus that *ké* is the realization of a verbal φ -probe that is connected to movement of the goal. This analysis finds a clear analogue in Romance (past) participle agreement, which is tied to extraction of the goal out of the vP (see [Belletti 2017](#) and references cited there). An Italian example is provided in (26). In the passive construction (26b), the

⁹ [Van Urk \(2015:217, 2018:948\)](#) notes that treating *ké* as the realization of a head in the clausal spine would require violating the Head Movement Constraint ([Travis 1984](#)) because it is possible for the main verb to move over it to a V2 position. However, much recent work has shown that there are several cases of head movement that descriptively violate the Head Movement Constraint (e.g., [Rivero 1994](#), [Roberts 1994](#), [Harizanov 2019](#), [Harizanov and Gribanova 2019](#)), so Dinka would in no way be exceptional in this regard. Moreover, excorporation analyses of head movement have been proposed by [Roberts \(1991, 2010\)](#). These analyses are compatible with treating *ké* as the realization of a verbal head.

Another question that arises for treating *ké* as the realization of *v* is why *ké* is morphologically identical to the 3rd person plural pronoun (thanks to Coppe van Urk, p.c., for raising this question). We suggest that this is an instance of syncretism rather than identity. Concretely, because the Vocabulary Item in (25) is specified only for [PL], it is also used to realize 3rd person plural pronouns (in other words, *ké* may realize both interpretable and uninterpretable [PL] features). We thus state the form identity between verbal *ké* and pronominal *ké* at the level of the Vocabulary Item, not at the level of the syntactic structure that it realizes.

verb agrees with the promoted internal argument *Maria*. This contrasts with the active-clause baseline in (26a), in which the participle does not agree.

- (26) a. *Maria ha assunto Susanna.*
 Maria has hired Susanna
 ‘Maria has hired Susanna.’ [Daniele Panizza, p.c.]
- b. *Maria è stata assunta.*
 Maria be.3SG been.F.SG hired.F.SG
 ‘Maria has been hired.’ [Belletti 2017:2975, ex. (3)]

Participle agreement appears in a range of configurations, which Kayne (1989) suggests correlate with A-extraction of the internal argument (as an instance of Spec–Head agreement, Kayne proposes). Our analysis of *ké* is similar in this regard. Arabic subject–verb agreement (where only preverbal subjects control number agreement; Harbert and Bahloul 2002) provides a related example of φ -agreement that correlates with movement (also see Zeijlstra 2012 and Bjorkman and Zeijlstra 2019).

Let us apply this proposal to a configuration in which an object undergoes \bar{A} -movement, such as (27). The resulting derivation is given in (28). In order for the object to be attractable to C, it must be closer to C than the external argument. *v* must therefore bear $[u\varphi]$, enabling leapfrogging and subsequent movement of *yeyíṅà* ‘who.PL’ to [Spec,CP]. The plural agreement on $[u\varphi]$ is then realized as *ké*.

- (27) **Yeyíṅà** *cíi Ból ké tṭṭ?*
 who.PL PFV.NSV Bol.GEN PL see
 ‘Who all did Bol see?’ [Van Urk and Richards 2015:127, ex. (23b)]

(28) Derivation of (27)

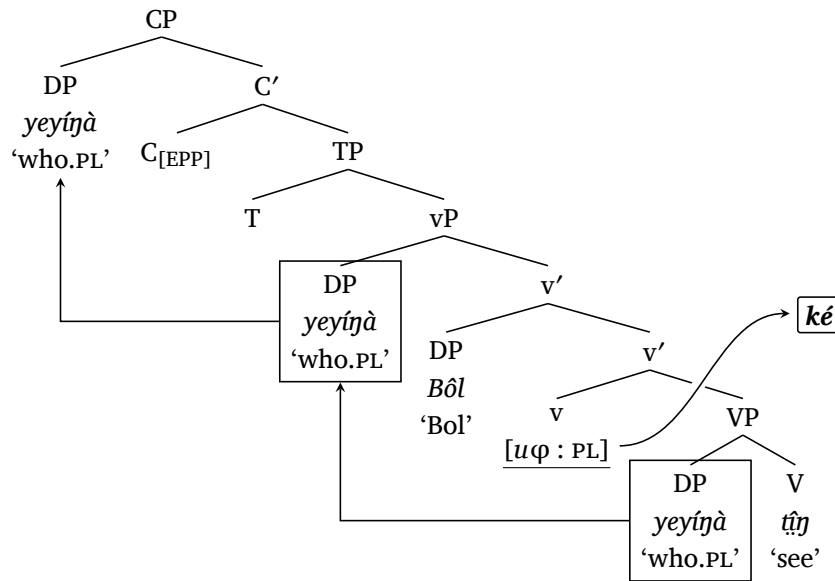

By contrast, if a local subject is extracted to [Spec,CP], as in (29), no *ké* appears. This is because in order for C to attract the external argument, it must be the closest element to C. This is the case only if no leapfrogging of a lower DP takes place, hence if *v* does not bear [*uφ*]. Because *ké* is the realization of [*uφ*], it follows that no *ké* appears in such configurations.¹⁰

- (29) **Ròḡḡor** áa-cé (***ké**) yîin tîiŋ.
 men 3P-PFV (*PL) you see.NF
 ‘The men have seen you.’

[Van Urk 2018:950, ex. (25a)]

- (30) Derivation of (29)

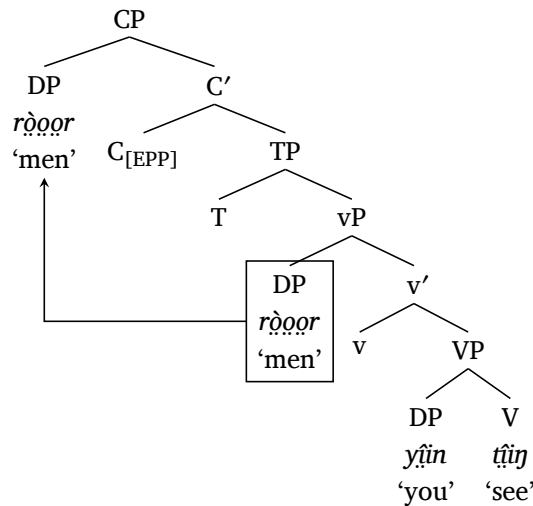

Note that there is no look ahead: if *v* bears [*uφ*], leapfrogging will take place and a DP other than the external argument will move to [Spec,CP]. By contrast, if *v* does not bear [*uφ*], no leapfrogging takes place and the external argument moves to [Spec,CP]. The choice of whether to equip *v* with [*uφ*] is free, with different consequences for what DP will move to [Spec,CP]. In this way, the analysis derives the basic split between subjects and lower DPs from intervention instead of vP phases.

This analysis of *ké* as the realization of plural agreement on *v* also accounts for the fact that while *ké* appears only if the \bar{A} -extracted element is plural, it is insensitive to the person of the moving element, as shown in (31). The absence of person marking seems more problematic if *ké* is analyzed as a pronoun that realizes an intermediate landing site, though see Van Urk (2018:960–974) for an analysis.

¹⁰ One derivation that needs to be ruled out involves [*uφ*] on *v*, which agrees with the external argument as Spec-Head agreement. Various analytical possibilities exist. First, one might relate it to the fact that external arguments of transitive verbs bear genitive or oblique case, unlike objects, which bear absolutive case (Andersen 2002, 2007, Van Urk 2015, 2018). Agree between [*uφ*] and the external argument can then be ruled out by case discrimination (Bobaljik 2008). Alternatively, we suggest below that the distribution of [*uφ*] is subject to economy in the sense that its appearance is licensed only if it has an “effect on outcome” (Chomsky 2001:34) by enabling leapfrogging. This is the case only if [*uφ*] agrees with, and attracts, an object or adjunct. As a result, [*uφ*] does not agree with the external argument because in such configurations [*uφ*] would not be licensed to begin with.

- (31) **Wɔ̀ɔk/Wêek** cǐ Áyèn ké tǐn.
 1PL/2PL PFV.OV Ayen.GEN 3PL see.NF
 ‘Us/You all, Ayen has seen.’ [Van Urk 2015:225, ex. (62a,b)]

Let us turn next to the empty-edge effect. As discussed in section 4.1, such effects appear with ditransitive verbs. Recall that in such constructions, one object must appear before the verb and one following the verb (see (32)). Furthermore, if \bar{A} -movement of an object out of this vP takes place, it must empty the preverbal position and cannot empty the postverbal position (see (33)).

- (32) a. Yêen cǐ Ayén yiên kitáp.
 I PFV Ayen give book
 b. Yêen cǐ kitáp yiên Ayén.
 I PFV book give Ayen
 ‘I gave Ayen a book.’ [Van Urk and Richards 2015:124–125, ex. (19a,b)]

- (33) a. Yeɲà₁ cǐ môc ___₁ yiên kitáp?
 who PFV.NSV man.GEN give book
 ‘Who did the man give the book to?’
 b. *Yeɲó₁ cǐ môc Ayén yiên ___₁?
 what PFV.NSV men.GEN Ayen give
 ‘What did the men give Ayen?’ [Van Urk and Richards 2015:125, ex. (20a,d)]

As noted in section 4.1, Van Urk (2015, 2018) and Van Urk and Richards (2015) analyze this restriction in terms of vP phases. On their analysis, v bears an EPP property, requiring one of the two objects to move to [Spec,vP]. Subsequent \bar{A} -movement can then only target this element, not the VP-internal, postverbal object. Interestingly, Van Urk (2015:151–154) argues that [Spec,vP] may only be filled by the structurally closer object and that configurations in which the indirect object appears preverbally are derived from a different base configuration than configurations in which the direct object appears preverbally. In other words, he argues that (32a,b) differ in their base structure as shown in (34) and (35), respectively (Van Urk 2015:153, 154). Whichever object occupies the preverbal position is base-generated as the higher object within the VP.

- (34) *Van Urk’s (2015) structure for (32a)*

$$[\text{vP Ayén } v^0 [\text{AppIP } t \text{ AppI}^0 [\text{VP yiên kitáp }]]]$$
 Ayen give book

- (35) *Van Urk’s (2015) structure for (32b)*

$$[\text{vP kitáp } v^0 [\text{VP } t \text{ yiên } [\text{PP } P^0 \text{ Ayén }]]]$$
 book give Ayen

In these structures, the displacement to [Spec,vP] is string-vacuous, driven only by the assumption that vP is a phase. If we question this assumption, the possibility emerges that in fact no displacement to [Spec,vP] takes place in (34) and (35) and that the two object DPs remain in their base positions. Let us suppose so. Let us furthermore suppose that [$u\phi$] on v may only agree with the closest ϕ -bearing element. If v 's search space contains two ϕ -bearing DPs, only the higher one may be attracted and hence leapfrog over the external argument. This has the effect that in ditransitive constructions, only the higher object may move to [Spec,CP] (as such movement requires leapfrogging over the external argument). This is schematized in (36), where [$u\phi$] may only attract the higher object *yeηà* 'who' to the outer [Spec,vP]. The postverbal object could not be attracted by [$u\phi$] due to intervention by the higher object. This derives the contrast in (33) from Van Urk's (2015) structure for ditransitives and relativized minimality in the probing of [$u\phi$].

(36) Derivation of (33a)

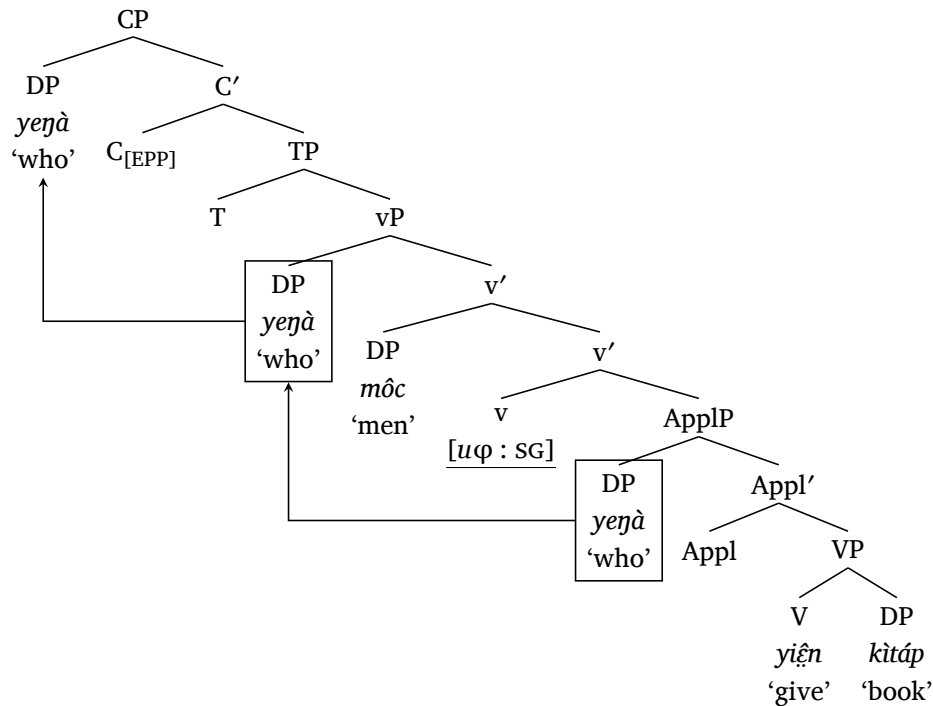

Our treatment of object extraction in transitive (30) and ditransitive (36) clauses gives rise to a question. Recall that in a transitive structure without movement of the object, the verb follows the object, as shown in (37).

(37) Yĕen cĕ mĭir tĭŋ.
 I PFV giraffe see
 'I saw a giraffe.'

[Van Urk and Richards 2015:122, ex. (14a)]

But in a ditransitive structure, the verb is sandwiched between the two objects. We suggest that these word order differences are not the result of movement, but reflect a different linearization of the verb relative to its complement. More specifically, we propose that the standard

[Comp,V]–V order in transitives switches to a V–[Comp,V] order in ditransitives. We ground this asymmetry in case assignment (or nominal licensing). [Stowell \(1981\)](#) proposes that case assignment is subject to an adjacency condition, such that a case-assigning verb must be directly precede or follow an object that it case-licenses (also see [Chomsky 1980, 1981](#), [Janke and Neeleman 2012](#), [Baker 2014](#), [Levin 2015](#), [Belk and Neeleman 2017](#), [Erlewine, Levin and Van Urk 2017](#), [Erlewine 2018](#), and [Van Urk 2020b](#) for various alternative proposals of how to implement an adjacency condition on nominal licensing, either involving Case or not). In Dinka ditransitive constructions, both objects bear unmarked absolutive case, the same case as direct objects of transitives ([Van Urk 2015:148](#)). It therefore stands to reason that both objects receive case from the verb. But the adjacency condition on case assignment prevents such case assignment if the word order is OOV or VOO, as stated in (38).

- (38) a. *DP_{ABS} DP_{ABS} V
 b. *V DP_{ABS} DP_{ABS}

The only way for the verb to be adjacent to both objects in order to license them is to be sandwiched between them, hence an OVO word order. This, we propose, is what causes the emergence of OVO in ditransitive constructions. Concretely, while V’s complement ordinarily precedes V, it is exceptionally linearized to the right in order to circumvent violating (38).

- (39) a. *Transitive:*
 [VP DP V] *complement precedes V*
 b. *Ditransitive:*
 [VP/AppIP DP V DP] *complement follows V to respect (38)*

This proposal is consistent with the familiar view that the order between a verb and its specifier is fixed but the ordering between a head and its complement is variable (at least as a parameter setting; for recent discussion and proposals, see [Epstein, Groat, Kawashima and Kitahara 1998](#), [Saito and Fukui 1998](#), [Richards 2004](#), [Abels and Neeleman 2009, 2012](#), [Sheehan 2013](#), and in the context of attested orderings of subject, object, and verb relative to each other, see [Dryer 2013](#) and [Tvica 2017](#)).¹¹ On this analysis, the change in the order between the verb and its arguments from transitive to ditransitive vPs is not the result of movement, but differential linearization of the verb and its complement. These differential linearizations are themselves conditioned by (38) and ultimately derive from an adjacency requirement on nominal licensing.

We note also that subjects in Dinka do not affect the linearization of the verb relative to the object, even if the subject is not fronted to the clause-initial position. As shown in (40), the subject *Áyèn* and the object *cujìn* ‘food’ both appear in preverbal position.

- (40) Pǎal à-cɛ̀nɛ́ Áyèn cujìn cǎam.
 knife 3SG-PFV.OBLV Ayen.GEN food eat.NF
 ‘With a knife, Ayen has eaten food.’ [[Van Urk 2015:61](#), ex. (3c)]

¹¹ See, e.g., [Neeleman and Weerman \(1999\)](#) and [Manetta \(2012\)](#) for the idea that the linearization of a verb and its complement may be variable even within the same language.

The fact that the VO linearization is triggered only by a second object but not by a subject follows immediately from our account. The subject in (40) does not appear in the unmarked absolutive case, but rather in an oblique (Andersen 2002, 2007) or genitive (Van Urk 2015, 2018) case form. This case also appears on subjects of unergative and unaccusative verbs (Van Urk 2015:86–87), and hence does not seem to be assigned by the verb. If subjects do not depend on licensing by the verb, then there is no need to invert the [Comp,V]–V order to bring them into a verb-adjacent position (we hence formulated (38) in such a way that it applies only to sequences of two absolutive DPs).

On our proposal, the immediately preverbal gap position that arises under object \bar{A} -movement as in (41) is not [Spec,vP], but simply the base position of the object, thus simplifying the syntax underlying object placement in Dinka.

- (41) Yeŋà₁ c̄jì môc ___₁ yīɛn k̄itáp?
 who PFV.NSV man.GEN give book
 ‘Who did the man give the book to?’ [Van Urk and Richards 2015:125, ex. (20a)]

One consequence of this account is that it offers a new solution to a puzzle with PP extraction. The puzzle is that PP extraction does *not* empty the preverbal position. This is illustrated in (42). The element *ye b̄ɛ̄ɛi k̄ô* ‘(to) which villages’ is \bar{A} -moved, resulting in *ké*. Importantly, however, the immediately preverbal position (underlined in (42)) is not emptied but instead occupied by the object DP *w̄ɛ̄nm̄áth* ‘brother’.

- (42) **Ye b̄ɛ̄ɛi k̄ô** cénnè nȳɛ̄nk̄ái ké w̄ɛ̄nm̄áth tuòc?
 Q villages which PFV.OBLV sister PL brother send
 ‘Which villages did my sister send my brother to?’
 [Van Urk and Richards 2015:130, ex. (30a)]

On Van Urk and Richards’s (2015) and Van Urk’s (2015) account, where the preverbal position is [Spec,vP] and must be targeted by intermediate movement due to vP phasehood, the fact that PPs apparently do not need to pass through this [Spec,vP] requires additional assumptions. To account for configurations like (42), Van Urk and Richards (2015) and Van Urk (2015) propose that PPs pass through a second, outer [Spec,vP], which is not available to DPs so that emptying of the inner [Spec,vP] only arises with DP extraction. On the account we propose here, (42) follows without additional assumptions to this effect. This is because the base position of these PP elements is invariably postverbal. As exemplified by (43) (also see (12)), the PP *w̄í̄ɛ̄t* ‘cattle camp.LOC’ cannot appear in the preverbal position but must instead appear postverbally.

- (43) a. Bòl à-cé Dèŋ tuòc **w̄í̄ɛ̄t**.
 Bol 3SG-PFV Deng send cattle.camp.LOC
 ‘Bol sent Deng to the cattle camp.’
 b. *Bòl à-cé **w̄í̄ɛ̄t** tuòc Dèŋ.
 Bol 3SG-PFV cattle.camp.LOC send Deng
 ‘Bol sent Deng to the cattle camp.’ [Van Urk and Richards 2015:129, ex. (28a,b)]

(46) Derivation of (44)

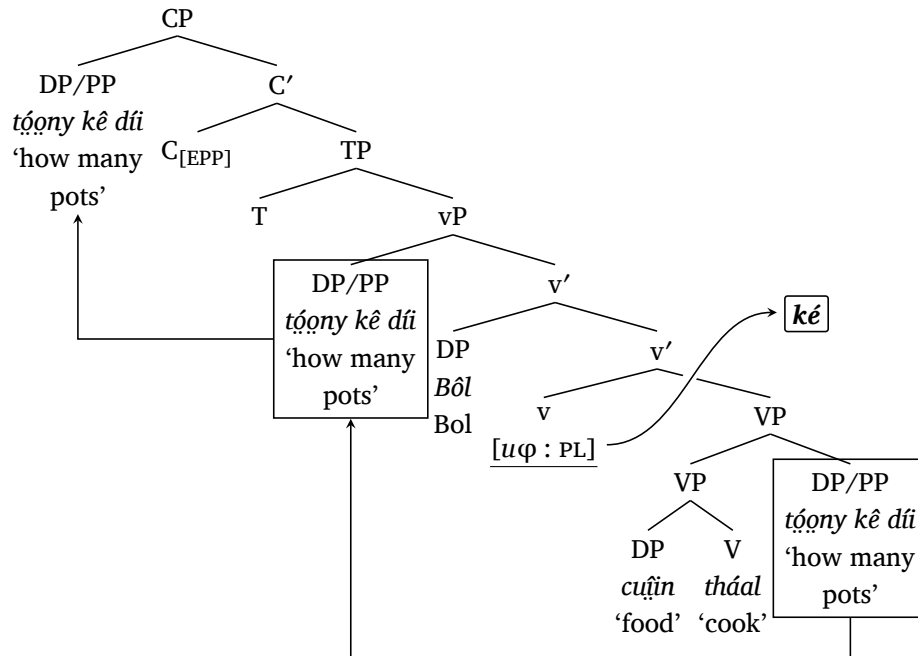

Finally, we note that the presence of an adjunct does not interfere with \bar{A} -movement of an object (see Van Urk 2015:61, 2018:942). This follows from the assumption that the base position of adjuncts is variable and hence may be lower than the base position of verbal arguments (Larson 1988, 2004, Pesetsky 1995, Lechner 2003, Csirmaz 2005:90–98).¹³

Finally, let us now turn to unaccusatives. Recall from (21), repeated here as (47), that \bar{A} -extraction of the subject of an unaccusative does not lead to *ké*.

- (47) Yè [_{CP} pɛ̀ɛl-kó bɛ́ (*kɛ́) dhuɔ̀ŋ]?
 be knives-which FUT (*PL) break.NF
 ‘Which knives will break?’ [Coppe van Urk, p.c.]

But extraction of an adjunct out of an unaccusative vP does induce *ké* if plural, as shown again in (48), repeated from (22). This demonstrates that unaccusative v may carry [uφ].

- (48) Yè [_{CP} thèek-kó bɛ́i pɛ̀ɛl kɛ́ dhuɔ̀ŋ]?
 be times-which FUT.OV knives PL break.NF
 ‘At which times will the knives break?’ [Van Urk 2015:168, ex. (81)]

We noted above that, on a vP-phase account, the contrast between (47) and (48) gives rise to a conundrum because the unaccusative vP would need to act as a phase for the extraction in (48) but not for the extraction in (47). Our minimality account offers an explanation. In (47), no DP intervenes between C *pɛ̀ɛl-kó* ‘which knives’ and hence no leapfrogging is required. By

¹³ In principle, we predict that structurally higher adverbs, in particular ones that are generated vP-externally, should be able to front without triggering *ké* because they are not dependent on leapfrogging and hence [uφ]. Unfortunately, it seems impossible to assess this prediction because *ké* is generally only triggered by plural elements. Adverbs do not meet this requirement and so are not expected to give rise to *ké* in any case.

contrast, in (48) *pèel* ‘knives’ intervenes between C and *thèek-kó* ‘which times’, and leapfrogging is hence necessary to derive (48). Focusing on intervention instead of vP phases thus enables a principled account of why *ké* appears in (48) but not in (47).

Let us first consider the derivation for (48). The unaccusative subject *pèel* ‘knives’ in (48) appears in a position that precedes the verb (and *ké*). This indicates that the internal argument of an unaccusative verb undergoes movement to a higher position, and this is what underlies the need for leapfrogging of the PP. We treat this position as a [Spec,vP]. That is, we attribute to v an EPP property that requires a DP in its specifier. Ordinarily, this requirement is fulfilled by the external argument by being generated in [Spec,vP], and no movement is necessary. In structures with no external argument, the internal argument moves to [Spec,vP].¹⁴ If a PP is to be \bar{A} -extracted across this raised DP, as in (48), leapfrogging is thus required, leading to *ké* if the PP is plural.

Finally, we turn to (47), where the unaccusative subject itself is extracted, and *ké* does not appear. Due to v’s EPP feature and the lack of an external argument, the DP argument first undergoes movement to [Spec,vP], followed by extraction to [Spec,CP], as shown in (49).

(49) Derivation of (47)

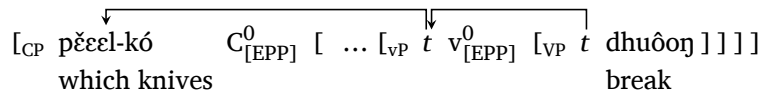

Recall that we assumed that $[u\phi]$ is optionally present on v. If v in (49) contained $[u\phi]$, we would expect *ké*. Note that normally $[u\phi]$ occurs to enable leapfrogging, which is not a factor in (49). We propose, therefore, that the distribution of $[u\phi]$ is subject to economy, its appearance being licensed only if has an “effect on outcome” (Chomsky 2001:34) by enabling an otherwise impossible extraction. Because extraction to [Spec,CP] is possible in (49) regardless of the presence of $[u\phi]$, its appearance is then prohibited.¹⁵

¹⁴ We share this assumption with Van Urk (2015, 2018) and Van Urk and Richards (2015), but note that for Van Urk (2015, 2018) and Van Urk and Richards (2015), the external argument cannot satisfy v’s EPP requirement and as a result, on their analysis movement of an object is always required. This raises the question as to why the external argument cannot satisfy v’s EPP requirement; on our analysis, this question does not arise.

¹⁵ An alternative to economy is to adopt a recent proposal by Martinović (2015, 2017), who suggests a morphological OCP condition on head–specifier configurations. This constraint prohibits identical ϕ -features from surfacing on a head and the closest specifier of that head—that is, if the two are structurally adjacent, as in (i).

(i) Morphological Obligatory Contour Principle (OCP) constraint in Dinka

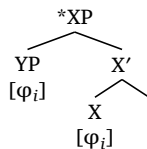

In a configuration that violates (i), it is not possible to morphologically realize $[\phi_i]$ on both X and YP. This restriction strongly resembles Chomsky and Lasnik’s (1977) Doubly Filled Comp Filter, and can be seen as a morpho-syntactic haplology effect that can be attested in many other cases as well (Koopman 1996, 1999, 2000, Sportiche 1996, Pearson 2005, Baltin 2010). In line with Martinović’s (2015, 2017) proposal, in configurations that violate (i), $[\phi_i]$ on X is deleted.

(ii) Delete $[u\phi : PL]$ on v if structurally adjacent to the $[PL]$ -bearing agreement controller.

In (49), (i) is violated because both v and its nearest specifier bear agreeing ϕ -features. (ii) hence applies, which deletes $[\phi]$ on v and thereby bleeds *ké*.

To summarize this section, the alternative analysis we proposed does not appeal to vP phases in any way but instead derives the pattern from intervention and the concomitant need for leapfrogging. The key intuition underlying the account is that C in Dinka may only attract the closest goal. For an element other than the closest one to be attracted by C, it must first move around the highest DP. We have analyzed *ké* as the realization of the probe that gives rise to this movement. On this account, vP itself is not a locality domain to extraction by C and the pattern hence does not constitute evidence for vP phasehood. We showed how the shift from phasehood to intervention allows us to understand the otherwise paradoxical behavior of unaccusative vPs with respect to *ké*.

5. *meN*-deletion in Indonesian

A second influential argument for vP phases that we will reconsider here comes from Standard Indonesian and a dialect of Malay used by educated speakers in Singapore. The basic pattern is that the active voice prefix *meN-* is obligatorily deleted if a DP other than the local subject undergoes \bar{A} -movement over it (Saddy 1991, Cole and Hermon 1998, Soh 1998, Fortin 2006, Aldridge 2008b, Cole, Hermon and Yanti 2008, Sato 2012, Georgi 2014, Jeoung 2018). Aldridge (2008b), Cole et al. (2008), Sato (2012), Georgi (2014), and Jeoung (2018) all interpret this pattern as evidence for vP phases. While their respective accounts differ substantially, the guiding analytical intuition is that any nonlocal subject DP must move to the vP phase edge on its way to [Spec,CP], and this movement to [Spec,vP] bleeds *meN-*. We argue for an alternative analysis along the lines suggested for Dinka in section 4. DPs other than the local subject must leapfrog over the local subject due to minimality, and this leapfrogging leads to *meN*-deletion. Similar to Dinka, evidence for an intervention account comes from the observation that only extraction of some elements out of a vP induces *meN*-deletion.

5.1. The pattern

Standard Indonesian has an active-voice marker *meN-* (where *N* can take different context-dependent phonological shapes). According to some authors, *meN-* is optional in sentences that allow it (see Georgi 2014:53—who cites Macdonald and Darjowidjojo 1967:238—, Fortin 2006:48, and Jeoung 2018:ch. 3 for Indonesian; and Cole and Hermon 1998:231, Soh 1998:295–297, and Soh and Nomoto 2009:150 for Malay), while other authors describe *meN-* as obligatory if it is possible (Cole et al. 2008:1504, Sato 2012:43). This seems to be a matter of dialectal or register variation (Soh 1998:296, Cole et al. 2008), which we put aside here. What we will focus on here is configurations in which *meN-* becomes impossible.

In the baseline example (50a), the verb bears the prefix *meN-*. Crucially, when a DP other than the local subject undergoes \bar{A} -movement, *meN-* is obligatorily deleted, as illustrated with object movement in (50b). If the local subject undergoes movement, *meN-* does not need to delete (50c).

- (50) a. *Baseline*
 Ali telah **mem**-baca buku itu.
 Ali PFV MEN- read book the
 ‘Ali has read the book.’ [Soh 1998:296, ex. (6)]
- b. *Object extraction*
Apa-kah₁ yang Ali telah (***mem**-)baca ___₁?
 what-Q that Ali PFV (*MEN-) read
 ‘What has Ali read?’ [Soh 1998:297, ex. (9b,c)]
- c. *Subject extraction*
Apa-kah₁ yang ___₁ telah **mem**-baca buku itu?
 who-Q that PFV MEN- read book the
 ‘Who has read the book?’ [Soh 1998:297, ex. (9a)]

In constructions with two DP objects, \bar{A} -movement of either bleeds *meN*-.

- (51) *\bar{A} -movement in ditransitive constructions*
- a. **Apa**₁ yang kamu (***mem**-)beli-kan ibu-mu ___₁?
 what that you (*MEN-) buy-APPL mother-your
 ‘What did you buy your mother?’
- b. **Siapa**₁ yang kamu (***mem**-)beli-kan ___₁ bunga?
 who that you (*MEN-) buy-APPL flower
 ‘Who did you buy a flower/flowers?’ [Sato 2012:43, ex. (18b,c)]

If the extraction is long-distance, *meN*- must disappear on every verb that is crossed by it. This is illustrated for long object extraction in (52). For long subject extraction, *meN*- does not need to delete in the lowest clause (in line with (50c)) but in all higher ones, as in (53).

- (52) *Long object extraction*
Siapa-kah₁ yang Ali (***meng**-)anggap [Minah \emptyset -suka ___₁]?
 who-Q that Ali (*MEN-) believe Minah like
 ‘Who does Ali believe Minah likes?’ [Soh 1998:298, ex. (11b,c)]
- (53) *Long subject extraction*
Siapa-kah₁ yang Ali (***meng**-)anggap [___₁ **men**-yukai Karim]?
 who-Q that Ali (*MEN-) believe MEN-like Karim
 ‘Who does Ali believe likes Karim?’ [Soh 1998:297–298, ex. (11a,d)]

This pattern is not limited to wh-movement, but also holds for other \bar{A} -movements, such as relativization (Cole and Hermon 1998:233, Sato 2012:34) and focus movement (Cole and Hermon 1998:233).

Significantly, \bar{A} -movement of elements that are not DPs does not have this effect (Cole and Hermon 1998, Soh 1998, Fortin 2006, 2007, Sato 2012). Movement of PPs or adverbs does not induce *meN*-deletion, even if the element originates within the vP, as shown in (54). If a

non-DP undergoes long movement, no *meN*-deletion takes place in either clause, as illustrated in (55).

(54) *Non-DP movement*

- a. [**Kepada siapa-kah**]₁ Minah **mem-beri** kucing kesayangannya ___₁?
to who-Q Minah MEN- give cat beloved.her
‘To who did Minah give her beloved cat?’ [Soh 1998:313, ex. (32b)]
- b. **Kenapa**₁ Mary **mem-beli** buku itu ___₁
why Mary MEN- bought book that
‘Why did Mary buy that book?’ [Cole and Hermon 1998:231, ex. (26a)]

(55) *Long non-DP movement*

- a. [_{CP} [**Kepada siapa**]₁ kamu **meng-harapkan** [_{CP} Ali akan **mem-beri**
to who you MEN- hope Ali FUT MEN- give
mobil + nay ___₁]]?
car + 3SG
‘To who do you hope Ali will give his car?’
- b. [_{CP} **Mengapa** kamu **meng-harapkan** [_{CP} Ali akan **mem-beli** mobil]]?
why you MEN- hope Ali FUT MEN- buy car
‘Why do you hope Ali will buy a car?’ [Fortin 2007:51–52, ex. (73), (78)]

In a nutshell, then, every DP that \bar{A} -moves across a transitive verb triggers deletion of *meN*-.

5.2. vP-based accounts

Aldridge (2008b), Cole et al. (2008), Sato (2012), and Georgi (2014) all interpret this pattern as evidence for vP phases. While their respective accounts differ in significant ways, the guiding analytical intuition is that an object DP must move to [Spec,vP] on its way to [Spec,CP], and this movement to [Spec,vP] bleeds *meN*-. Where these accounts differ is how this bleeding effect is implemented. Aldridge (2008b) and Sato (2012) propose that v bears a designated feature that attracts an object DP to its edge (EPP for Aldridge 2008b; [+D] for Sato 2012), which then prevents realization of *meN*-. The fact that extraction of non-DPs does not bleed *meN*- is somewhat puzzling under these accounts. If non-DPs must check this feature to reach the vP edge, then they too should block *meN*-, contrary to fact. On the other hand, if they can reach the vP edge without checking this feature, then it is not clear why DPs cannot do so as well. A second obstacle to such an account is why [EPP]/[+D] is not checked by the external argument in [Spec,vP]. This would incorrectly bleed *meN*- even if no object movement takes place.¹⁶

¹⁶ The latter problem is similar to a problem we identified for Van Urk’s (2015, 2018) and Van Urk and Richards’s (2015) account of Dinka in section 4.2.

Cole et al. (2008) propose that *v* acquires the Case features of all DPs in its specifier(s).¹⁷ Movement of an object to [Spec,vP] leads to an [ACC] specification in addition to the [NOM] specification contributed by the external argument, which gives rise to a feature conflict, which *meN-* does not tolerate, leading to ungrammaticality. Extending this account to long-distance subject extraction such as (53) would seem to require additional assumptions because both specifiers of the higher *v* bear [NOM], which does not obviously create a feature conflict.

Another line of approach is developed by Georgi (2014:151–156), who proposes that *meN-* is bled by an impoverishment rule that is triggered if [Spec,vP] contains a DP with a valued case feature. The fact that only DPs delete *meN-* follows from the formulation of the impoverishment rule. The subject/object asymmetry is captured because the impoverishment applies only if the DP has a valued case feature. Subjects are taken to receive case in [Spec,TP], so that the copy in [Spec,vP] is caseless and hence does not trigger the rule. This analysis appears at odds with the standard view that feature valuation takes place in syntax and impoverishment applies postsyntactically. On this architecture, all features are valued by the time impoverishment applies, and as a result impoverishment cannot distinguish between DPs with valued and unvalued case features. The subject–nonsubject distinction would then be lost.

5.3. A leapfrogging analysis

Our alternative analysis is inspired by these previous accounts, and it maintains the core intuition that *meN-* deletion is triggered by movement of a DP to [Spec,vP]. In contrast to these analysis, however, we ground this movement not in vP phases, but in minimality/intervention, in the same manner as for Dinka. By assumption, just like C in Dinka, C in Indonesian can only attract the structurally closest element (with an important addition to be discussed shortly), following proposals by Aldridge (2004, 2008a), Erlewine (2018), Branau and Erlewine (2020), and Coon et al. (to appear). This restriction is of course quite common in Austronesian languages. In contrast to Dinka, Indonesian is not a V2 language, and so it is not the case that C is simply equipped with an [EPP] feature that attracts the closest element. For Indonesian, we adopt Erlewine’s (2018) and Coon et al.’s (to appear) proposal that an \bar{A} -probe may be specified not just for an \bar{A} -feature but also for a categorial feature (also see Baier 2018). We thus assume that C in Indonesian has the makeup in (56) (to be extended below). (56) contains a complex probe that searches for both [*uFoc*] and [*uD*].

(56) C: [*uFoc* + *uD*]

Erlewine (2018), Coon and Keine (to appear), and Coon et al. (to appear) argue that complex probes of this type cannot attract a fully-matching goal over a partially matching one. This restriction is stated in (57) and schematized in (58). In (58), the probe [*uA* + *uB*] comprises the two segments [*uA*] and [*uB*]. YP contains only a matching feature [A], and ZP contains a full [A + B] match. It is then not possible for the probe to attract ZP over YP.

¹⁷ Erlewine (2016) outlines a related analysis, on which *v* records the categorial feature of every element that it merges with. A [D,D] specification is then taken to be ill-formed, leading to obliteration of *v*, hence the disappearance of *meN-*.

(57) A complex probe cannot attract a fully-matching element across a partially-matching element.

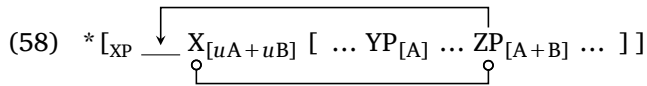

Erlewine (2018:686–687) implements (57) at the level of the Agree operation: a complex probe that encounters a partially-matching element stops probing. It therefore the Agree step in (58) that is illicit (and movement is thus impossible to begin with). Coon et al. (to appear) derive this result from Coon and Keine’s (to appear) feature-gluttony system, according to which it is the movement step in (58) that is impossible. The choice does not matter for our account here. We will therefore focus on the effects of (57) for Indonesian, rather than on the specific way (57) is implemented.

If the [uFoc]-bearing element is the external argument, no question of intervention arises. But if it is a lower DP that bears [uFoc], the external argument intervenes. As in Dinka, this intervention results in the need for leapfrogging. For the sake of concreteness, we will treat this leapfrogging as being triggered by an optional, noncriterial [uFoc] feature on v.¹⁸ We then analyze *meN*-deletion as a reflex of [uFoc] on v. Drawing on and adapting Georgi’s (2014) account, we treat *meN*- as an active-voice marker (see (59)) and appeal to the impoverishment rule in (60), which deletes active voice in the context of [uFoc].

(59) /*meN*-/ ↔ [VOICE: ACT]

(60) [VOICE: ACT] → ∅ / __ [uFoc]

In the case of subject \bar{A} -movement, no leapfrogging must take place, as schematized in (61). Assuming that the distribution of [uFoc] on v is subject to economy (following the Dinka analysis, though see fn. 15 and 18 for possible alternatives) and that [uFoc] is only present when it enables leapfrogging, v lacks [uFoc] in (61). The condition for (60) is hence not met, and no *meN*-deletion takes place.¹⁹

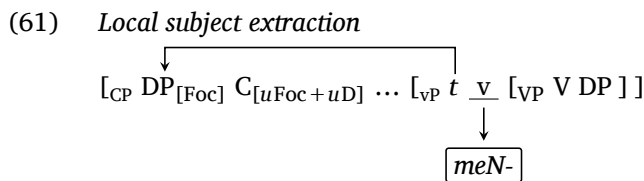

Turning now to \bar{A} -movement of an object DP, C cannot attract such an object across the external argument due to (57). The object must hence first leapfrog over the external argument, requiring the presence of [uFoc] on v. Application of (60) is therefore obligatory, leading to obligatory deletion of *meN*-, as shown in (62).

¹⁸ Alternatively, v always bears [uFoc], but it is checked only if there is a [Foc] DP. The rule in (60) can then be stated as applying in the context of a checked [uFoc] feature.

¹⁹ This account works most straightforwardly for varieties of Indonesian and Malay in which *meN*- is obligatory when it is possible (Cole et al. 2008, Sato 2012). As mentioned above, in other varieties *meN*- is generally optional when it is possible. This optionality is independent of extraction. In line with much of the previous literature, we take it for granted that optional *meN*-deletion unrelated to extraction is the result of an independent process in these varieties, arguably a spell-out mechanism.

(62) *Local object extraction*

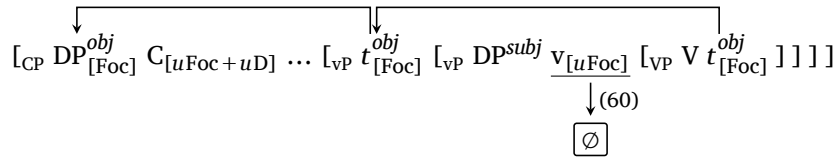

Long-distance DP extraction proceeds analogously. In order for the embedded argument to be attractable by matrix C, it must first leapfrog around the external argument of the matrix clause, requiring matrix v to bear [uFoc] and hence bleeding *meN*- in the matrix clause.

Let us now turn to extraction of non-DPs. Here, our account diverges from vP phase accounts in a particularly clear way. Recall from (54) that \bar{A} -extraction of PPs and adverbs does not lead to obligatory *meN*-deletion even if the element clearly originates within the vP. A relevant example is repeated in (63). Here, local extraction of a PP object does not delete *meN*-.

(63) [**Kepada siapa-kah**]₁ Minah **mem-beri** kucing kesayangannya ___₁?
to who-Q Minah MEN- give cat beloved.her
‘To who did Minah give her beloved cat?’ [Soh 1998:313, ex. (32b)]

Let us take (63) at face value: if obligatory *meN*-deletion is a reflex of successive-cyclic movement through vP, then the fact that it does not apply in (63) suggests that the movement in (63) does *not* proceed through vP. Such an analysis is of course impossible if vP constitutes a phase, but it becomes available on the intervention/minimality account we propose here. Broadly speaking, our suggestion is that for C in Indonesian, minimality is assessed on a categorial level: if C attracts a DP, it must be the closest DP; if C attracts a PP, it must be the closest PP, etc. To derive this behavior, we postulate that (56) is not the only possible featural makeup for C in Indonesian. C’s specification is not limited to [uFoc + uD] (which would limit \bar{A} -extraction to DPs), but can also take the form in (64b) and (64c).

- (64) a. C: [uFoc + uD] (= (56))
b. C: [uFoc + uP]
c. C: [uFoc + uAdv]

(64b) and (64c) attract focused PPs and adverbs, respectively. Importantly, nonfocused DPs do *not* constitute a partial match to either (64b) or (64c). Such DPs therefore do not cause an intervention effect, in line with (57) and (58). This has the crucial consequence that PPs and adverbs do not need to leapfrog over the external argument, which is always a DP. PPs and adverbs may therefore move to [Spec,CP] in one-fell-swoop, which explains why no *meN*-deletion takes place in such cases. This contrast is illustrated for DP extraction and PP extraction in (65). As (65a) shows, the external argument constitutes a partial match to C_[uFoc+uD], hence requiring leapfrogging and *meN*-deletion. By contrast, PP extraction requires C_[uFoc+uP]. Because the external argument is not a partial match to this probe, the PP may be attracted to C directly. Leapfrogging and *meN*-deletion do not apply. The same is true for \bar{A} -movement of adverbs (not shown in (65)).

(65) a. *One-fell-swoop extraction of a lower DP impossible*

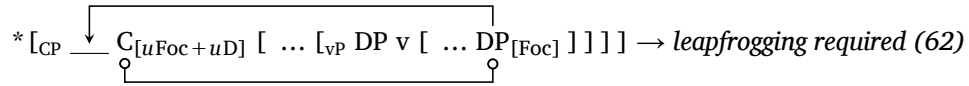

b. *PP-extraction possible without leapfrogging*

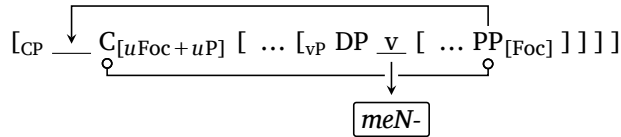

This account offers a new perspective on why *meN*-deletion arises only with DP extraction. Because the external argument is always a DP, it causes intervention only for DP attraction by C, not for attraction of other categories. The DP/non-DP asymmetry is thus derived from category-based intervention (57) and the fact that external arguments are DPs. This line of explanation is not available on a vP-phase account. On such an account, *all* extraction must pass through [Spec,vP], and it is therefore necessary to encode in some other way that only DPs in [Spec,vP] have this effect but PPs and adverbs do not. Dispensing with vP phases hence paves the way for a tighter connection between *meN*-deletion and successive cyclicity through vP: *meN*-deletion is obligatory *if and only if* movement passes through [Spec,vP].

A prediction that now emerges from the intervention account is that even DP movement should not bleed *meN*- if there is no external argument and so no leapfrogging is necessary. This prediction seems to be borne out. As discussed by Sato (2012), Georgi (2014), Jeoung (2018), it is possible for *meN*- to mark intransitive verbs, including unaccusative verbs. An example is provided in (66). Jeoung (2018:81) provides several examples of intransitive verbs that may bear *meN*-, including prototypically unaccusative verbs like *me-letus* ‘burst’, *men-cair* ‘melt’, *men-didih* ‘boil’, and *men-ikah* ‘be married’.²⁰

(66) Harga elektrik tiba-tiba {turun/**men**-urun}.
 price electricity suddenly fall MEN-fall
 ‘The price of electricity suddenly fell.’

[Jeoung 2018:87, ex. (52)]

In (66), if *harga elektrik* ‘the price of electricity’ had passed through [Spec,vP] on its way to [Spec,TP], we would expect obligatory *meN*-deletion, contrary to fact. This indicates that the subject moves to [Spec,TP] in one-fell-swoop, as shown in (67).

²⁰ Some comments are in order. First, Soh and Nomoto (2011) propose that Indonesian does not have unaccusative verbs and that instead all intransitive verbs are unergative in the language. See Sato (2012:44–46) and the references cited there for arguments against this view. Second, Sato (2012) proposes that *meN*- that appears on unaccusative verbs is distinct from *meN*- on transitive verbs because the former contributes a progressive meaning component absent in the latter. But doing so not only leaves it unexplained why the two have the same form (Soh and Nomoto 2011:88, Georgi 2014:155n100), there also seems to be little empirical motivation for such a split. Soh and Nomoto (2009) provide relevant evidence showing that *meN*- is impossible in sentences that denote states (also see Soh and Nomoto 2011). Importantly, this restriction holds for both transitive and intransitive verbs, and Soh and Nomoto (2009, 2011) conclude that *meN*- should be treated as the same item with both types of verbs. Moreover, Jeoung (2018:87–88) shows that even with unaccusative verbs, the progressive interpretation seems to be a preference rather than a semantic requirement. We therefore follow Soh and Nomoto (2009, 2011) and Georgi (2014) in treating *meN*- on intransitive verbs as the same voice marker as on transitive verbs.

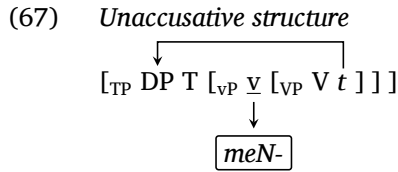

This structure is also adopted by Sato (2012:46). To account for the fact that no landing site in [Spec,vP] is necessary, Sato (2012) adopts Chomsky’s (2000, 2001) assumption that unaccusative *v* does not behave as a phase. This is sufficient to derive the absence of *meN*-deletion, but it is not unproblematic. First, it is at odds with the vP-phase account for Dinka, which required unaccusative vP to be a phase. Second, it amounts to a stipulation because nothing in the concept of phases results in the split between agentive and unaccusative *v*, as discussed in fn. 7, and notably, no equivalent split holds for CPs. By contrast, our minimality account offers a more principled explanation. Because there is no external argument that would require leapfrogging over it in (67), it follows automatically that movement may proceed in one-fell-swoop and hence that no obligatory *meN*-deletion takes place.

Finally, we note that the lack of *meN*-deletion with unaccusative verbs cannot be due to a split between A- and \bar{A} -movement because even A-movement induces *meN*-deletion if it crosses a DP in [Spec,vP]. Relevant evidence comes from object-preposing constructions like (68), which requires *meN*- to delete (Chung 1976:51).

- (68) Ali₁ saya (***men**-)cubit ____ 1.
 Ali I (***MEN**-)pinch
 ‘I pinched Ali./Ali was pinched by me.’

[Cole and Hermon 1998:232, ex. (28b), Sato 2012:34, ex. (5)]

Chung (1976) provides evidence that this object preposing targets an A-position (see also Guilfoyle, Hung and Travis 1992, Cole and Hermon 1998, and Sato 2012). For example, it may be controlled PRO, and it may undergo raising. Moreover, there is evidence that the agent in (68) is an argument DP rather than an adjunct (Guilfoyle et al. 1992, Arka and Manning 1998, Cole et al. 2008, Aldridge 2008b). For example, Arka and Manning (1998) show that the agent may antecede a fronted reflexive. Our minimality account thus derives the need for *meN*-deletion: the presence of the DP argument in (68) makes leapfrogging of the internal argument necessary, and this leapfrogging induces *meN*-deletion.

To summarize, the overarching pattern in Indonesian is that *meN*-deletion applies whenever a DP is moved over another DP in [Spec,vP]. A minimality-based account offers a principled explanation of this pattern: in order to be attractable by C, the lower DP must first leapfrog over the higher DP, and this leapfrogging induces *meN*-deletion. If such leapfrogging is not necessary because either there is no higher DP or because the lower element is of a different category (PP or adverb), *meN*-deletion does not apply. The principles of minimality and intervention thus provide a close match to the distribution of *meN*-deletion.

An account that uses vP phases does not lend itself to such an explanation. All else being equal, such an account predicts that *all* extraction out of vP must pass through [Spec,vP] and hence give rise to *meN*-deletion. Further stipulations are thus required to accommodate the configurations in which *meN*-deletion does not apply, including that unaccusative *v* does not

require movement through its specifier and that movement of non-DP elements to [Spec,vP] does not result in *meN*-deletion. As a result, a shift away from vP phases to a minimality account does not only seem feasible but in fact justified. With vP phases thus being removed from the account, we conclude that the Indonesian facts do not provide empirical evidence for vP phases and that they may even (depending on the analysis) constitute evidence against vP phases.

6. Extraction morphology in Defaka

Both case studies considered so far involve successive cyclicity through an outer [Spec,vP]. We proposed that this successive cyclicity is not driven by vP phases but by minimality: in order to be attractable by C, an object must leapfrog across the external argument in an inner [Spec,vP] position. Because of the analytical shift away from vP phases to minimality, our account leads one to expect similar effects in projections other than vP. For example, if the external argument moves to [Spec,TP], then leapfrogging of a lower DP would have to target an outer [Spec,TP]. Clearly, an account that attributes the successive cyclicity to vP phases does not give rise to this expectation. In this section, we consider extraction morphology in Defaka (Bennett 2009, Bennett, Akinlabi and Connell 2012). We argue that Defaka instantiates a language where T shows leapfrogging effects instead of v.

6.1. Empirical evidence

Defaka is an SOV language that allows focus fronting of maximally one XP. This fronting has morphological effects. As shown in (69b), when a local subject is focus-fronted, it bears a focus marker *kò*; the verb morphology remains unaffected. When any element other than the local subject undergoes focus fronting, two reflexes arise, illustrated in (69c). First, the fronted XP bears the focus marker *ndò*. Second, the verb bears the special morphological marker *kè*. In what follows, we simply gloss *kè* as “KE” in the examples. We follow Bennett (2009) and Bennett et al. (2012) in glossing *kò* as “FOC.SBJ” but as we will see immediately below, *kò* appears only if it is the *local* subject that has undergone focus fronting.²¹

- (69) a. *No focus-fronting*
 ì Bòmá ésé-kà-rè
 I Boma see-FUT-NEG
 ‘I will not see Boma.’
- b. *Local-subject focus*
 ì kò Bòmá ésé-kà-rè
 I FOC.SBJ Boma see-FUT-NEG
 ‘I will not see Boma.’

²¹ In order to stay as close as possible to the original examples as possible, we maintain Bennett’s (2009) and Bennett et al.’s (2012) convention of indicating focus by means of underlining in the free translation.

c. *Object focus*

Bòmá **ndò** ì ésé-kà-rè-kè
 Boma FOC I see-FUT-NEG-KE
 ‘I will not see Boma.’

[Bennett et al. 2012:294, ex. (1)–(3)]

Importantly, the split sets local subjects apart from all other fronted elements. That is, fronting of adjuncts patterns like fronting of objects, as shown in (70): the fronted XP bears *ndò*, and the verb bears *kè*. This includes locative adverbs and temporal adverbs.

(70) *Adjunct focus* → *kè*

a. [ándù kikià] **ndò** à èbèrè rì bòi-mà-kè
 canoe under FOC the dog KE hide-NFUT-KE
 ‘The dog is hiding under the canoe.’

[Bennett et al. 2012:296, ex. (15)]

b. òmòmò **ndò** Bòmá ìbò tínà árí-kè
 now FOC Boma big fish catch-KE
 ‘Boma caught a big fish just now.’

[Bennett 2009:18, ex. (59b)]

c. [nùmá bíò] **ndò** ò à tínà árí-kè
 that river FOC he the fish catch-KE
 ‘He caught the fish in that river.’

[Bennett 2009:18, ex. (61b)]

Long focus fronting is possible, and in this case, *kè* arises in the way just described on all verbs crossed by movement. If an object is moved nonlocally, both the embedded verb and the matrix verb bear *kè*, as (71) shows.

(71) *Nonlocal-object focus*

ándù₁ **ndò** Bòmá fàà-kè [CP ìní ___₁ été-kè]
 canoe FOC Boma say-KE they have-KE
 ‘It’s a canoe that Boma said that they have.’

[Bennett et al. 2012:297, ex. (21)]

If an embedded subject is fronted nonlocally, *kè* does not appear on the embedded verb, but it must appear on the matrix verb. Additionally, *ndò* must appear in the matrix clause rather than *kò*. This is illustrated in (72).

(72) *Nonlocal-subject focus*

Bruce₁ **ndò**/***kò** Bòmá jíí-*(**kè**) [CP ___₁ á ésé-mà]
 Bruce FOC/*FOC.SBJ Boma know-*(KE) her see-NFUT
 ‘Boma knows (that) Bruce saw her.’

[Bennett et al. 2012:297, ex. (18)]

The fact that the fronted embedded subject in (72) must be marked with *ndò* and cannot be marked with *kò* makes it pattern with fronted objects. This makes it clear that the choice between *ndò* and *kò* does not draw the distinction between subjects and nonsubjects per se, but between local subjects and everything else—the same distinction that conditions the appearance of *kè*. In other words, *kè* appears whenever the fronted element is accompanied by *ndò*, and *kè* and *ndò* are mutually exclusive with *kò*.

6.2. vP-phase account

Bennett (2009) and Bennett et al. (2012) argue that the distribution of *kè* provides evidence for vP phases (also see Van Urk 2016, 2020a,c). They propose that focus extraction of any element that is not located at the vP edge requires it to first move to [Spec,vP] in order to leave the vP phase. *Kè* is then analyzed as reflecting such intermediate movement. Such movement is required for nonsubjects and nonlocal subjects but not for local subjects, which are base-generated at the vP edge. Importantly, however, Bennett (2009) and Bennett et al. (2012) argue that *kè* is *not* located within the vP but within a higher head (which they dub “X⁰”) that is located between vP and TP. The reason is that movement of the vP does not move *kè* along, as would be expected if *kè* were part of the vP. The authors suggest that *kè* selects for a vP that bears a [+Focus] feature (which attracts an element to its edge). Thus, if v attracts a [+Focus] element to its edge, then the next-higher head is realized as *kè* as schematized in (73).²²

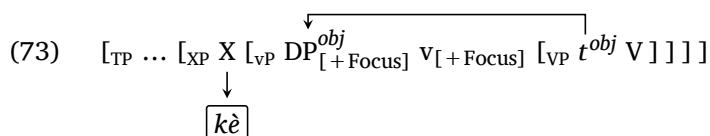

On Bennett’s (2009) and Bennett et al.’s (2012) analysis, the link between vP phasehood and *kè* is thus only indirect in the sense that *kè* is not a direct reflex of movement to [Spec,vP] or the feature that underlies it.

Next, in order to account for the distribution of *ndò* and *kò*, Bennett (2009) and Bennett et al. (2012) locate these elements in the left periphery. Concretely, they propose that the clausal spine contains one projection that licenses a subject (“SubjP”) and a higher FocusP projection. If any element other than the local subject is fronted, this element occupies [Spec,FocusP] while the local subject is located in [Spec,SubjP], as shown in (74). In this case, Focus⁰ is realized as *ndò*.

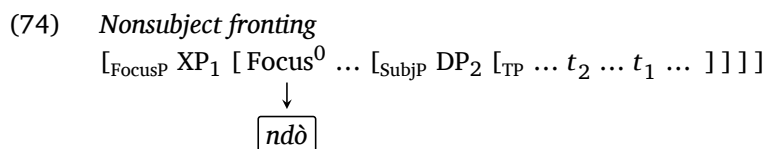

Building on work by Giorgi and Pianesi (1996), they then propose that if a local subject is focus-fronted, these two projections are combined into a joint {Focus–Subj} projection, whose specifier is occupied by a fronted local subject, as shown in (75). This {Focus–Subj} head is then realized as *kò*.

²² Bennett (2009) and Bennett et al. (2012) assume subsequent movement of the vP to [Spec,TP] to obtain the correct word order. Because this movement does not bear on the treatment of *kè*, we do not represent it in (73).

(75) *Local-subject fronting*

$$[_{\{\text{Focus-Subj}\}P} \text{DP}_1 [\{\text{Focus-Subj}\}^0 [_{\text{TP}} \dots t_1 \dots]]]$$

$$\downarrow$$

$$\boxed{k\grave{o}}$$

They furthermore assume that if a joint Focus–Subj projection is possible, it must be used, making *kò* obligatory with local-subject extraction.

Bennett’s (2009) and Bennett et al.’s (2012) analysis is insightful, and we will preserve several key aspects of it in our own account, but also faces a number of concerns, to which we now turn. First, while Bennett (2009) and Bennett et al. (2012) appeal to vP phasehood to derive the distinction between local subjects (which originate at the vP edge) and objects (which must move, hence triggering *kè*), it is not at all clear that this analysis handles adjuncts correctly. As shown in (70), adjunct fronting likewise triggers *kè*. On a vP phase account, this would require that *all* adjuncts are base-generated within the VP so that they must move to [Spec,vP] in order to be extracted to CP. Bennett (2009) and Bennett et al. (2012) do not provide independent support for the claim that all relevant adverbs originate vP-internally. The fact that even locative and temporal adverbs—which generally have to be vP-external given their scopal behavior—behave in this way and would hence need to be generated inside the vP casts serious doubts on this crucial part of the account.

To put this objection somewhat differently, vP phases derive a distinction between elements at the vP edge and VP-internal material. But empirically, the crucial split in Defaka is between local subjects on the one hand and everything else on the other. If only local subjects and objects are considered, these two line up. But once adjuncts are brought into the picture, the empirical split between local subjects and everything else does not correlate (under standard views about the position of adjuncts) with the distinction between VP-internal and VP-external material that vP phases give rise to. We take this as an indication that it is not vP that underlies the split.

In addition, the vP-phase analysis faces a conceptual problem as well. As shown in section 6.1, the distribution of *kè* correlates with that of *ndò*, which marks fronted XPs other than local subjects. Despite the fact that the two markers appear under the same conditions, Bennett’s (2009) and Bennett et al.’s (2012) analysis treats them separately: *kè* is analyzed in terms of vP phases, while *ndò* is attributed to properties of higher functional projections. In light of the similarities in the distribution of *kè* and *ndò*, one might wonder whether it is not possible to analyze *kè* in terms of higher functional projections as well. Note that such a more unified analysis would also be consistent with Bennett’s (2009) and Bennett et al.’s (2012) view that *kè* realizes a vP-external head. In the next section, we will develop such an analysis. This analysis will not only link *kè* and *ndò* more directly, it also obviates the need for vP phases.

6.3. A leapfrogging analysis

The analysis we develop preserves Bennett’s (2009) and Bennett et al.’s (2012) key idea that the distribution of *ndò* and *kò* is conditioned by whether the projection that hosts the subject and the Focus projection are conflated into a single projection or not. But we show that this line

of analysis can be extended to *kè*, thus obviating the need to additionally appeal to vP phases. For the sake of concreteness, let us assume a simple CP > TP > vP > VP clause structure, as before. C is responsible for focus-fronting an XP, and in line with our accounts of Dinka and Indonesian, C may only attract the closest DP. Furthermore, we assume with Bennett (2009) and Bennett et al. (2012) that the subject raises to a vP-external position in Defaka, which we identify as [Spec,TP]. As a result, if a nonsubject is to be \bar{A} -extracted, it must first move to an outer specifier of TP in order to be attractable by C. We also follow Bennett (2009) and Bennett et al. (2012) in the assumption that if T and C would have the same element in their specifiers, they are conflated into a single {C-T} projection that comprises the features of both T and C.²³

Against this background, we propose that *ndò* and *kò* are the realization of C and that *kè* is the realization of T. Their precise specifications are given in (76). All three realize [*uFoc*] features, but they differ in the context of this [*uFoc*] feature. First, *ndò* in (76a) realizes [*uFoc*] on a C head in the context of an overt specifier (that is, *ndò* is not triggered by an intermediate landing site). Second, *kò* in (76b) realizes [*uFoc*] on a conflated {C-T} head, also in the context of an overt specifier. Third, *kè* in (76c) realizes [*uFoc*] on a T head, the feature responsible for leapfrogging. The restriction of *ndò* and *kò* to heads with an overt specifier is to limit their appearance to the final landing site of the movement chain. We assume that vocabulary insertion follows chain reduction and hence that the information about whether a copy is overt or not is available to vocabulary insertion.

- (76) a. /*ndò*/ ↔ C_[*uFoc*] / [_{CP} XP ____
 b. /*kò*/ ↔ {C-T}_[*uFoc*] / [_{{C-T}P} XP ____
 c. /*kè*/ ↔ T_[*uFoc*]

As in our analyses of Dinka and Indonesian, we assume that C in Defaka may only attract the closest element, even in cases where an intervening element is not focused. Because fronting is associated with a focus interpretation in Defaka, we broadly adopt the analysis of Indonesian, according to which C bears a complex probe. Unlike Indonesian, however, intervention is not category-specific in Defaka. Fronting of PPs and adverbs requires *kè* and hence leapfrogging. We therefore propose the complex probe in (77).

- (77) C: [*uFoc* + *uX*]

Here, the feature [*uX*] is a “catch-all” feature that is not category-specific but can instead be matched by a variety of categories, including DPs, PPs, and adverbs. In this respect, it is similar to the attracting feature in V2 languages like Dinka or German, where a variety of elements

²³ We adopt the conflation aspect of Bennett’s (2009) and Bennett et al.’s (2012) account for two reasons. First, it allows for an easier comparison between the two approaches, demonstrating that it is possible to dispense with vP phases while leaving other aspects of their account intact. Second, the idea that certain heads can be conflated has been independently proposed for heads in the IP domain (Bobaljik 1995, Thráinsson 1996, Giorgi and Pianesi 1996, 1997, Bobaljik and Thráinsson 1998), in the CP domain (Bianchi 1999), across these two domains (Gallego 2017), and in the vP domain (Pylkkänen 2002, 2008, Harley 2017). Additionally, Legate (2011, 2014), Martinović (2015, 2019), and Erlewine (2018) have argued that C and T can be conflated into a single head for Acehnese, Wolof and Toba Batak, respectively. Finally, Hsu (2016, to appear) develops a general theory of head bundling across a number of domains.

may be used to satisfy the V2 requirement.²⁴ In a way, then, (77) combines aspects of our analysis of Dinka (where movement involves an underspecified EPP-property) and of Indonesian (where movement is triggered by a complex probe). Recall from the analysis of Indonesian that complex probes like (77) cannot attract a fully-matching element over a partially-matching one (Erlewine 2018, Coon and Keine to appear, Coon et al. to appear). As a consequence of (77), C cannot attract a focused element over a nonfocused subject. This results in the need for leapfrogging in the by now familiar way.

Let us consider a number of specific configurations. We begin with local-object \bar{A} -movement, illustrated in (78). In this configuration, the object bears a [Foc] feature. After the subject A-moves to [Spec,TP], it intervenes between C and the focused object. The complex probe (77) can therefore not attract the object from its base position. Object extraction thus requires leapfrogging of the object to an outer [Spec,TP] above the subject, triggered by [uFoc] on T. C can then attract the object to [Spec,CP] because the object matches both [uX] and [uFoc]. Given the items in (76), the derivation in (78) results in T being realized as *kè* and C as *ndò*.

(78) *Local-object fronting*

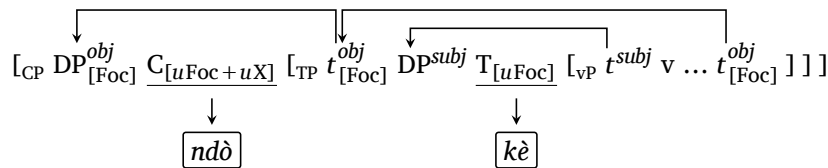

Next, consider \bar{A} -fronting of a local subject, schematized in (79). Following the proposal in Bennett (2009) and Bennett et al. (2012), in this case C and T are conflated into a single {C-T} head that subsumes the featural content of both C and T. Movement of the focused subject to [Spec,{C-T}P] simultaneously satisfies T's EPP requirement and C's [uFoc + uX].²⁵ In line with the items in (76), the {C-T} head is realized by *kò*.

(79) *Local-subject fronting*

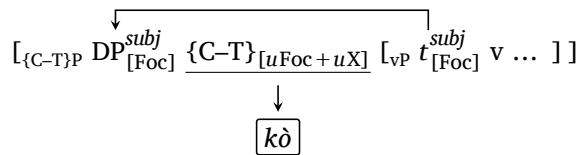

Third, let us consider a configuration in which an adjunct to TP is \bar{A} -extracted, such as the temporal adverb in (70b). The structure is schematized in (80). If the to-be-focused adjunct is base-generated below T, [uFoc] on T attracts the adjunct to an outer [Spec,TP], leading to *kè*, as above. If the adjunct is base-generated in an outer [Spec,TP], [uFoc] on T agrees with the adjunct in its base position, either as an instance of Spec-Head agreement (Mahajan

²⁴ [uX] in (77) could therefore be thought of as a maximally underspecified category feature. This conception raises the question why the TP does not intervene for Agree between C and a DP. A plausible explanation is that TP is too local for attraction by C (Abels 2003, 2012) and that elements that are too local are simply ignored for the operation of probes (Branan 2019).

²⁵ See also Van Urk (2015) for the general proposal that a single movement step may satisfy both A- and \bar{A} -features on a head.

1989, Chomsky 1991, 1993, Koopman 2006), cyclic Agree (Rezac 2003, 2004, Béjar and Rezac 2009), or Upward Agree (Zeijlstra 2012, Carstens 2016, Bjorkman and Zeijlstra 2019).²⁶

The adverb then undergoes focus movement to [Spec,CP]. As a result, T is realized as *kè*, and C is realized as *ndò*.

(80) *TP-adverb fronting*

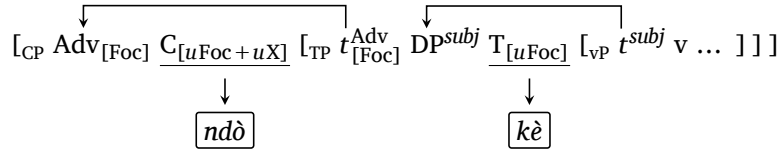

Next, let us turn to long-distance movement of an object. Such movement results in *kè* in every clause that is crossed by movement and in *ndò* in the clause that hosts the criterial position of the moved DP. The relevant structure is given in (81). Because CP is a phase, extraction out of the embedded clause must proceed through [Spec,CP], which we assume is triggered by a noncriterial counterpart of (77) on the intermediate C.²⁷ As in the previous cases, the [Foc]-bearing object is attracted by the embedded T, leading to leapfrogging over the subject. After subsequent movement to the embedded [Spec,CP], the object is then attracted by the matrix T's [uFoc], from where it is then attractable by the matrix C. Because both clauses hence contain a T with a checked [uFoc] feature, *kè* appears in both. By contrast, *ndò* appears only in the matrix clause because [uFoc] on the intermediate C is not in the context of an overt element in [Spec,CP], and insertion of *ndò* is therefore not licensed.²⁸

²⁶ We note that this account requires that T in (80) bears [uFoc] despite the fact that this feature is not required to bring about leapfrogging (that is, the adverb would be attractable by C even if T did not bear [uFoc]). This creates a potential conflict with our analyses of Dinka and Indonesian, where we assumed that the appearance of [uFoc] is constrained by economy. A number of possible solutions suggest themselves, and at present we have no way of distinguishing between them. First, one could assume that [uFoc] is always present on T and hence that there simply is no second version of T lacking [uFoc] that economy could prefer in (80). Second, rather than appealing to economy for Dinka and Indonesian, we could instead adopt Martinović's (2015, 2017) OCP account suggested in fn. 15. If the OCP filter and the resulting impoverishment rule are language-specific, then the contrast between Dinka and Defaka can be easily stated at this level. Third, we could assume with Bennett (2009) and Bennett et al. (2012) that subjects in Defaka move to a projection higher than TP (their "SubjP"). If so, then TP-adverbs still require leapfrogging over the subject in order to be attractable by C, and this licenses the appearance of [uFoc]. As far as we tell, the choice between these three options is immaterial for the rest of our account.

²⁷ Other implementations of obligatory movement through the CP phase edge are of course possible so long as these are restricted to the highest element in the clause, thus requiring leapfrogging over the embedded external argument.

²⁸ Of course, nothing prevents the embedded C from bearing a *criterial* [uFoc] feature. In this case, A-movement to the embedded [Spec,CP] is terminal and not followed by movement into the matrix clause (Rizzi 2006, 2010, 2015). The result is embedded focus fronting that is accompanied by an embedded *ndò*, an embedded *kè*. This is the correct result, as (i) shows (the matrix *kò* in (i) is the result of local fronting of the matrix subject *Bòmá*, an instance of the derivation in (79)).

(i) Bòmá ¹kó fàà-mà-(*kè) [_{CP} ándù₁ ndò iní ___₁ été-kè]
 Boma FOC.SBJ say-NFUT-(*KE) canoe FOC they have-KE
 'Boma said it's a canoe that they have.'

[Bennett et al. 2012:297, ex. (22)]

(81) *Nonlocal-object fronting*

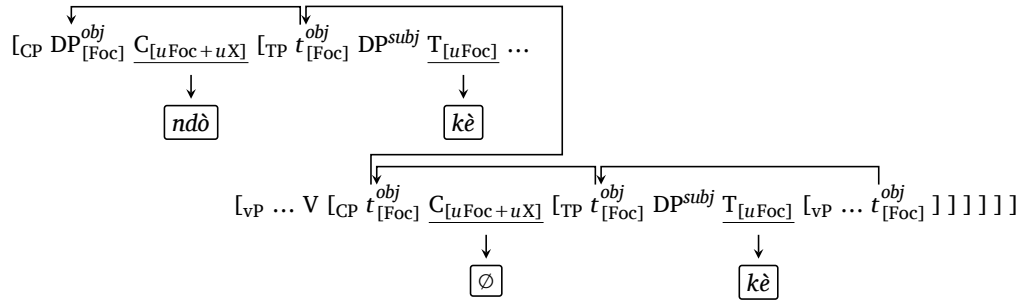

Finally, this account also handles nonlocal-subject extraction (see (72) for an example). In this case, the fronted embedded subject bears *ndò*, and *kè* appears on the matrix verb but not the embedded verb. The corresponding structure is given in (82). Due to CP phasehood, the embedded subject ($DP_{[Foc]}^{subj-2}$ in (82)) must first move to the edge of the embedded clause. Just as in (79), the embedded CP and TP are conflated into a single projection, which attracts the external argument to its specifier. From this position, the embedded subject must then move to an outer matrix [Spec,TP] in order to be attractable by the matrix C (due to intervention by the matrix subject DP^{subj-1}). It hence agrees with T's $[uFoc]$, followed by Agree with matrix C. In line with (76), the matrix C is realized as *ndò*, the matrix T as *kè*, and the embedded {C-T} as \emptyset because it is not in the context of an overt specifier.

(82) *Nonlocal-subject fronting*

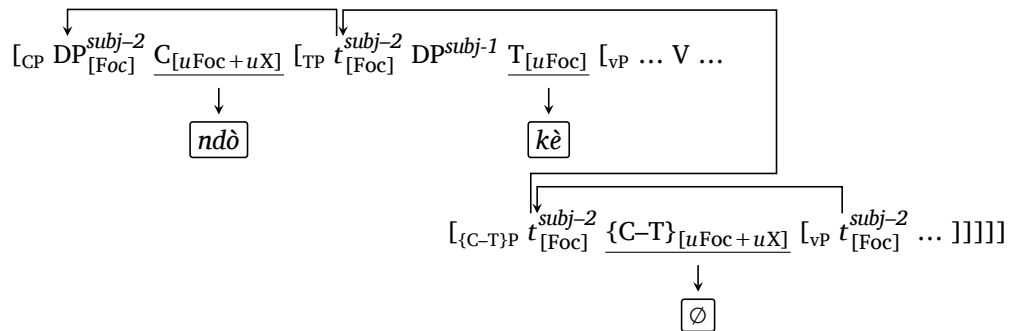

In sum, this alternative account of the Defaka facts derives the pertinent facts in section 6.1, but without appeal to vP phasehood or successive-cyclic movement through [Spec,vP]. The move away from vP phases resolves a number of problems that a vP-phase analysis faces. First, it offers a straightforward analysis of why \bar{A} -fronting of temporal and locative adverbs requires *kè* without needing to stipulate that such adverbs must be base-generated at VP. As such, unlike the vP-phase account, our account derives the crucial empirical split between local-subject movement and movement of everything else. If the local subject is \bar{A} -moved, TP and CP conflate, bleeding both *kè* and *ndò*. If any other element is focused, it first moves to an outer [Spec,TP], leading to *kè*. Second, our account establishes a closer connection between *ndò* and *kè*. As discussed in section 6.2, because *ndò* is clearly located in a structurally high position, it cannot be analyzed in terms of vP phases. Bennett's (2009) and Bennett et al.'s (2012) phase account therefore handles *kè* and *ndò* in an unrelated manner, despite the fact that their distribution is largely conditioned by the same factor (the presence of \bar{A} -movement

of an element other than the local subject). By locating both effects higher than vP, our analysis ties them together more closely. *Ndò* appears when an element other than the local subject is attracted to C, and these are the elements that first undergo leapfrogging over the local subject, yielding *kè*.

Lastly, in contrast to our analyses of Dinka and Indonesian, we have proposed that in Defaka the intermediate landing site of a moved element is in TP, not vP. This is consistent with Bennett's (2009) and Bennett et al.'s (2012) claim that subjects in Defaka move to [Spec,TP]. Leapfrogging around them must therefore target an outer [Spec,TP]. On our minimality account, it follows that the location of the intermediate landing site can be variable across languages (because it is conditioned by the position of the highest DP in the clause). On our analysis, then, *kè* appears at the syntactic locus of the effect (namely TP). This is not the case on a vP-phase account. Because such an account ties the effect to vPs even though *kè* does not appear in the vP, it must stipulate an indirect link between vPs and *kè*.

We conclude that an analysis of Defaka that does not involve vP phases is viable and offers a more principled understanding of the empirical generalizations. Like in the case of Dinka and Indonesian, the Defaka pattern does not provide clear evidence for vP phases.

7. Conclusion and outlook

7.1. Summary

We began this paper by identifying a number of systematic asymmetries in the locality effects of CPs and vPs in a number of domains, including movement, ϕ -agreement, case assignment, and negative concord. These locality effects exhibit the core properties of phases, and they have in common that CPs exhibit these effects but vPs systematically do not. This suggests that CPs and vPs are not on par as locality domains, and the traditional view that both CPs and vPs constitute phases does not offer a straightforward explanation for these asymmetries. Note in particular that it is not just the case that there are locality asymmetries between CPs and vPs. Particularly instructive is the fact that these asymmetries all go in the same direction, with CP constituting a locality domain that vP does not. We are not aware of any attempts to account for these systematic differences between the two domains while maintaining that they are both phasal, and it is not clear to us what such an account would look like.

These considerations led us to the question as to why it is that only CPs constitute locality domains for these processes. We have proposed that the simplest and most principled explanation emerges if we take these asymmetries at face value: CPs are phases, but vPs are not. The locality asymmetries then receive a principled explanation.

This view raises its own set of questions. If vP is not a phase, then previous arguments in favor of it being phasal call for reanalysis. The central goal of this paper was to reassess various arguments that have been made in the literature in favor of vP phases and to develop alternative analyses that do not invoke vP phasehood. We focused in particular on arguments that are based on morphological reflexes as several other arguments only show that it is possible to pass through [Spec,vP], a conclusion that is largely independent of the question whether vP is a phase. We furthermore focused on reflexes that involve a subject–nonsubject split,

which implicates a region of the clause lower than C. We investigated in detail three case studies that meet these requirements, and we proposed counteranalyses that do not involve vP phases. These counteranalyses share with vP-phase accounts that such elements must move through a clause-internal intermediate landing site (though not necessarily in vP). The crucial difference is that the need for this intermediate landing site is not caused by vP phases but rather by minimality: C may only attract the closest element, all else equal the external argument or subject. In order for another element to be attracted to C, this element must first leapfrog around the highest DP. This leapfrogging then manifests itself morphologically. Importantly, the limitation that C in some cases may only attract the closest element has been independently motivated in the recent literature to account for effects unrelated to extraction morphology (or vP phases) and it follows from general principles that govern the behavior of complex probes.

A central difference between the leapfrogging account and a vP-phase account is that the former does not require the effect to be at vP. If the highest DP is located in TP, then leapfrogging of a lower DP must target TP as well. By contrast, if the external argument remains in vP, then leapfrogging targets vP as well. The landing site of leapfrogging is therefore determined by the position of the external argument, and we have argued that this is a desirable consequence.

If these counteranalyses are successful, they suggest that at least these three case studies do not provide empirical support for vP phases, and it makes them compatible with the broader claim that vP is not a phase. In conjunction with the conclusion of section 3 that arguments that involve optional intermediate movement do not provide clear support for phasehood, the evidence for vP phases now seems fairly weak overall. One argument that we have not engaged with here is presented by [Manetta \(2010, 2011\)](#) on the basis of wh-scope marking in Hindi. Without going into the details of the argument or [Manetta's](#) analysis, we point the reader to [Dayal \(2017\)](#) for a reply and to [Dayal \(1994, 1996\)](#) and [Lahiri \(2002\)](#) for an alternative account of these constructions that does not involve vP phases. Another important argument for vP phases comes from [Abels's \(2003, 2012\)](#) stranding generalization, which holds that complements of phase heads may not be moved. [Abels](#) shows that VP may not be moved if it is embedded under a vP, as predicted if vP is a phase. If vP is not a phase, this argument is in need of reanalysis, which we leave for future work.

7.2. vPs vs. CPs

Our reanalysis of vP-phase effects as minimality raises important questions about the status of CP phases. In particular, given our reanalysis of vP-phase effects as minimality, we should ask whether an analogous reanalysis may be applied to CP-phase effects. If so, then phases could be dispensed with altogether. We believe that while some arguments for CP phases invite such a reanalysis, others do not. For the latter group, it is still necessary to appeal to CP phasehood.

An important property of phases is that, by the PIC ([Chomsky 2000](#)), the complement of the phase head is transferred upon completion of the phase and thereby removed from the workspace. This has the consequence that the complement will be inaccessible to all higher probes, regardless of whether there exists an intervener or not. As a consequence, while a minimality effect depends on the presence of an intervener that makes leapfrogging necessary,

a traditional phase effect obtains even in the absence of an intervener. As we will now show, several arguments for CP phasehood are of the latter type and involve effects arise even if there is no intervener in [Spec,CP]. These effects match what is expected if CP triggers phasal transfer of its complement, hence if CP is a phase.

For the sake of concreteness, let us consider complementizer shift in Irish (McCloskey 1979, 2001, 2002). Here, the complementizer, which normally appears in the form *go* as in (83a), must appear as *aL* if an element has \bar{A} -moved into its specifier (83b).

- (83) a. Deir siad **gur** ghoid na síogaí í.
 say they C-PAST stole the fairies her
 ‘They say that the fairies stole her away.’
- b. an ghirseach **a** ghoid na síogaí ____
 the girl aL stole the fairies
 ‘the girl that the fairies stole away’ [McCloskey 2001:67, ex. (1a,b)]

Importantly, if long movement takes place, every complementizer along the way changes, as shown in (84). This change is obligatory for each complementizer (McCloskey 2001:68, 2002: 185).

- (84) rud **a** gheall tú **a** dhéanfá ____
 thing aL promised you aL do
 ‘something that you promised that you would do’ [McCloskey 2001:68, ex. (4)]

While (83b) and (84) involve object extraction, *aL* also appears under subject extraction. An example is provided in (85).

- (85) an t-ainm **a** hinnseadh dúinn [**a** bhí ____ ar an áit]
 the name aL was-told to-us aL was on the place
 ‘the name that we were told was on the place’ [McCloskey 2002:185, ex. (5a)]

The fact that the embedded complementizer in (85) appears in the *aL* form reveals that the moved subject has passed through the embedded [Spec,CP], as schematized in (86). The need for successive cyclicity cannot be analyzed in terms of minimality or intervention (and hence leapfrogging) because there is no intervener between the gap and the embedded [Spec,CP] that would need to be skipped over. An account in terms of intervention would therefore not rule out one-fell-swoop movement, contrary to fact. By contrast, CP phases and the PIC enforce this requirement in the standard way. If CP is a phase, movement must pass through [Spec,CP] to escape the Transfer domain, regardless of whether there are other, intervening elements along the way.

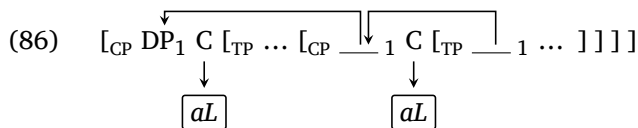

This conclusion is in line with the CP–vP asymmetries reviewed in section 2. For example, Polinsky’s (2003) and Bobaljik’s (2008) crosslinguistic generalization that long-distance agreement (LDA) may target an element in [Spec,CP] but not an element that is more deeply embedded in a CP holds regardless of whether there exists an intervening φ -goal (see (87), repeated from (1)). No analogous restriction holds for vPs, which block φ -agreement into them only if they contain an external argument that constitutes a closer goal. Again, the locality effect of CPs cannot be reduced to minimality, and in this respects it differs from vPs.

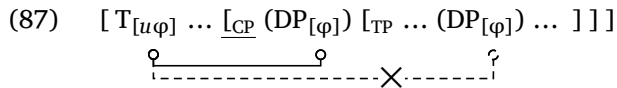

The same holds for the other dependencies reviewed in section 2: negative concord is blocked by finite CPs even if they do not themselves constitute or contain a closer goal; dependent-case assignment is blocked by CPs regardless of whether they contain an intervening DP; and movement that cannot target a phase edge is not allowed to skip an intermediate [Spec,CP] if there is no intervener. In all of these respects, CPs differ from vPs.

These considerations strongly suggest that the locality effect of CPs cannot be reduced to intervention and the resulting need for leapfrogging in the same way that we have proposed for vPs. Instead, the locality profile of CPs is exactly what we expect if they are phases and hence subject to the PIC. In this respect, CPs thus differ qualitatively from vPs, and treating both as phases obscures this significant asymmetry. We conclude, therefore, that it is neither possible nor desirable to reanalyze CPs as nonphases in the same way as we did for vPs here. Instead, attributing phasehood to the CP domain but not the vP domain offers a more principled explanation of the patterns we observe.

Abbreviations used in glosses

ACC	accusative	LOC	locative	PFV	perfective
APPL	applicative	NEG	negation	PL	plural
ERG	ergative	NFUT	nonfuture	P	preposition
FOC	focus	NF	nonfinite	QUANT	quantifier
FUT	future	NOM	nominative	Q	questions particle
F	feminine	NSV	nonsubject voice	SBJ	subject
GEN	gen	OBLV	oblique voice	SG	singular
HAB	habitual	OV	object voice	SV	subject voice
INF	infinitive	PAST	past	TR	transitive

Acknowledgements

Many thanks to Mitcho Erlewine, Omer Preminger, the audience at the Tel Aviv University Linguistics Colloquium, and the reviewers and audience at GLOW 43. Special thanks to Coppe van Urk, whose detailed and insightful work on Dinka provided the inspiration for this paper, for helpful discussions of Dinka and much-appreciated feedback on earlier versions of our analysis.

References

- Abels, Klaus. 2003. Successive cyclicity, anti-locality, and adposition stranding. Ph.D. dissertation, University of Connecticut, Storrs, CT.
- Abels, Klaus. 2012. *Phases: An Essay on Cyclicity in Syntax*. Berlin: de Gruyter.
- Abels, Klaus and Ad Neeleman. 2009. Universal 20 without the LCA. In: *Merging Features: Computation, Interpretation, and Acquisition*, ed. by José Brucart, Anna Gavarró and Jaume Solà, Oxford: Oxford University Press, pp. 60–79.
- Abels, Klaus and Ad Neeleman. 2012. Linear asymmetries and the LCA. *Syntax* 15: 25–74.
- Agüero-Bautista, Calixto. 2001. Cyclicity and the scope of wh-phrases. Ph.D. dissertation, MIT, Cambridge, MA.
- Aldridge, Edith. 2004. Ergativity and word order in Austronesian languages. Ph.D. dissertation, Cornell University, Ithaca, NY.
- Aldridge, Edith. 2008a. Generative approaches to ergativity. *Language and Linguistics Compass* 2/5: 966–995.
- Aldridge, Edith. 2008b. Phase-based account of extraction in Indonesian. *Lingua* 118: 1440–1469.
- Andersen, Torben. 2002. Case inflection and nominal head marking in Dinka. *Journal of African Languages and Linguistics* 23: 1–30.
- Andersen, Torben. 2007. Auxiliary verbs in Dinka. *Studies in Language* 31: 89–116.
- Arka, I Wayan and Christopher Manning. 1998. Voice and grammatical relations in Indonesian: A new perspective. In: *Proceedings of the LFG98 Conference*, ed. by Miriam Butt and Tracy Holloway King, Stanford, CA: CSLI, available at: <http://web.stanford.edu/group/cslipublications/cslipublications/LFG/3/lfg98arkamanning.pdf>.
- Baier, Nico. 2018. Anti-agreement. Ph.D. dissertation, University of California, Berkeley.
- Baker, Mark. 2014. Pseudo noun incorporation as covert noun incorporation: Linearization and crosslinguistic variation. *Language and Linguistics* 15: 5–46.
- Baltin, Mark. 2010. The nonreality of doubly filled Comps. *Linguistic Inquiry* 41: 331–335.
- Béjar, Susana and Milan Rezac. 2009. Cyclic Agree. *Linguistic Inquiry* 40: 35–73.
- Belk, Zoë and Ad Neeleman. 2017. AP adjacency as a precedence constraint. *Linguistic Inquiry* 48: 1–45.
- Belletti, Adriana. 2017. (Past) participle agreement. In: *The Wiley Blackwell Companion to Syntax, 2nd edition, Vol. V*, ed. by Martin Everaert and Henk van Riemsdijk, Hoboken, NJ: Wiley, pp. 2972–3000.
- Bennett, Wm. G.. 2009. Two subject asymmetries in Defaka focus extraction, Qualifying Paper, Rutgers University, available at: <https://sites.google.com/site/wmgbennett/papers/Bennett%202009%20-%20Two%20subject%20asymmetries%20in%20Defaka%20focus%20extraction.pdf?attredirects=0&d=1>.
- Bennett, Wm. G., Akinbiyi Akinlabi and Bruce Connell. 2012. Two subject asymmetries in Defaka focus constructions. In: *Proceedings of the 29th West Coast Conference on Formal Linguistics (WCCFL 29)*, ed. by Jaehoon Choi, E. Alan Hogue, Jeffrey Punske, Deniz Tat, Jessamyn Schertz and Alex Trueman, Somerville, MA: Cascadilla Press, pp. 294–302.
- Bhatt, Rajesh. 2005. Long distance agreement in Hindi-Urdu. *Natural Language and Linguistic Theory* 23: 757–807.

- Bianchi, Valentina. 1999. *Consequences of Antisymmetry: Headed Relative Clauses*. Berlin: de Gruyter.
- Bjorkman, Bronwyn and Hedde Zeijlstra. 2019. Checking up on (φ -)Agree. *Linguistic Inquiry* 50: 527–569.
- Bobaljik, Jonathan. 1995. Morphosyntax: The syntax of verbal inflection. Ph.D. dissertation, MIT, Cambridge, MA.
- Bobaljik, Jonathan. 2003. Floating quantifiers: Handle with care. In: *The Second GLOT International State-of-the-Article Book*, ed. by Lisa Cheng and Rint Sybesma, Berlin: Mouton de Gruyter, pp. 107–148.
- Bobaljik, Jonathan. 2008. Where's Phi? Agreement as a postsyntactic operation. In: *Phi Theory: Phi-Features Across Interfaces and Modules*, ed. by Daniel Harbour, David Adger and Susana Béjar, Oxford: Oxford University Press, pp. 295–328.
- Bobaljik, Jonathan and Höskuldur Thráinsson. 1998. Two heads aren't always better than one. *Syntax* 1: 37–71.
- Boeckx, Cedric. 2003. *Islands and Chains: Resumption as Stranding*. Amsterdam: John Benjamins.
- Boeckx, Cedric and Kleanthes Grohmann. 2007. Putting phases in perspective. *Syntax* 10: 204–222.
- Bošković, Željko. 2002. A-movement and the EPP. *Syntax* 5: 167–218.
- Bošković, Željko. 2004. Be careful where you float your quantifiers. *Natural Language and Linguistic Theory* 22: 681–742.
- Bošković, Željko. 2005. On the locality of left branch extraction and the structure of NP. *Studia Linguistica* 59: 1–45.
- Bošković, Željko. 2007. Agree, phases, and intervention effects. *Linguistic Analysis* 33: 54–96.
- Bošković, Željko. 2014. Now I'm a phase, now I'm not a phase: On the variability of phases with extraction and ellipsis. *Linguistic Inquiry* 45: 27–89.
- Branan, Kenyon. 2019. Locality and anti-locality: The logic of conflicting requirements, Ms., National University of Singapore, available at: <https://ling.auf.net/lingbuzz/004796>.
- Branan, Kenyon and Michael Yoshitaka Erlewine. 2020. \bar{A} -probing for the closest DP, Ms., National University of Singapore, available at: <https://ling.auf.net/lingbuzz/005211>.
- Branigan, Phil and Marguerita MacKenzie. 2002. Altruism, \bar{A} -movement and object agreement in Innu-aimûn. *Linguistic Inquiry* 33: 385–407.
- Bruening, Benjamin. 2001. Syntax at the edge: Cross-clausal phenomena and the syntax of Passamaquoddy. Ph.D. dissertation, MIT, Cambridge, MA.
- Bruening, Benjamin. 2004. Two types of wh-scope marking in Passamaquoddy. *Natural Language and Linguistic Theory* 22: 229–305.
- Cable, Seth. 2012. The optionality of movement and EPP in Dholuo. *Natural Language and Linguistic Theory* 30: 651–697.
- Carstens, Vicki. 2016. Delayed valuation: A reanalysis of goal features, “upward” complementizer agreement, and the mechanics of case. *Syntax* 19: 1–42.
- Chomsky, Noam. 1957. *Syntactic Structures*. The Hague and Paris: Mouton.
- Chomsky, Noam. 1973. Conditions on transformations. In: *A Festschrift for Morris Halle*, ed. by Stephen Anderson and Paul Kiparsky, New York, NY: Academic Press, pp. 232–286.

- Chomsky, Noam. 1977. On *wh*-movement. In: *Formal Syntax*, ed. by Peter Culicover, Thomas Wasow and Adrian Akmajian, New York: Academic Press, pp. 71–132.
- Chomsky, Noam. 1980. On binding. *Linguistic Inquiry* 11: 1–46.
- Chomsky, Noam. 1981. *Lectures on Government and Binding*. Dordrecht: Foris.
- Chomsky, Noam. 1991. Some notes on economy of derivation and representations. In: *Principles and Parameters in Comparative Grammar*, ed. by Robert Freidin, Cambridge, MA: MIT Press, pp. 417–454.
- Chomsky, Noam. 1993. A minimalist program for linguistic theory. In: *The View from Building 20*, ed. by Ken Hale and Samuel Jay Keyser, Cambridge, MA: MIT Press, pp. 1–52.
- Chomsky, Noam. 2000. Minimalist inquiries: The framework. In: *Step by Step: Essays in Syntax in Honor of Howard Lasnik*, ed. by Roger Martin, David Michaels and Juan Uriagereka, Cambridge, MA: MIT Press, pp. 89–155.
- Chomsky, Noam. 2001. Derivation by phase. In: *Ken Hale: A Life in Language*, ed. by Michael Kenstowicz, Cambridge, MA: MIT Press, pp. 1–52.
- Chomsky, Noam. 2004. Beyond explanatory adequacy. In: *Structures and Beyond: The Cartography of Syntactic Structures, Vol. 3*, ed. by Adriana Belletti, Oxford: Oxford University Press, pp. 104–131.
- Chomsky, Noam. 2007. Approaching UG from below. In: *Interfaces + Recursion = Language? Chomsky's Minimalism and the View from Syntax-Semantics*, ed. by Uli Sauerland and Hans-Martin Gärtner, Berlin: de Gruyter, pp. 1–31.
- Chomsky, Noam. 2008. On phases. In: *Foundational Issues in Linguistic Theory: Essays in Honor of Jean-Roger Vergnaud*, ed. by Robert Freidin, Carlos Otero and Maria Luisa Zubizarreta, Cambridge, MA: MIT Press, pp. 89–155.
- Chomsky, Noam and Howard Lasnik. 1977. Filters and control. *Linguistic Inquiry* 8: 425–504.
- Chung, Sandra. 1976. An object-creating rule in Bahasa Indonesia. *Linguistic Inquiry* 7: 41–87.
- Citko, Barbara. 2014. *Phase Theory: An Introduction*. Cambridge, UK: Cambridge University Press.
- Cole, Peter and Gabriella Hermon. 1998. The typology of *wh*-movement. *Wh*-questions in Malay. *Syntax* 1: 221–258.
- Cole, Peter, Gabriella Hermon and Yanti. 2008. Voice in Malay/Indonesian. *Lingua* 118: 1500–1553.
- Comrie, Bernard and Edward Keenan. 1979. Noun Phrase Accessibility revisited. *Language* 55: 649–664.
- Coon, Jessica, Nico Baier and Theodore Levin. to appear. Mayan Agent Focus and the Ergative Extraction Constraint: Facts and fictions revisited, *Language*.
- Coon, Jessica and Stefan Keine. to appear. Feature gluttony, *Linguistic Inquiry*.
- Csirmaz, Aniko. 2005. Semantics and phonology in syntax. Ph.D. dissertation, MIT, Cambridge, MA.
- Dayal, Veneeta. 1996. *Locality in Wh-Quantification: Questions and Relative Clauses in Hindi*. Dordrecht: Kluwer.
- Dayal, Veneeta. 2017. Does Hindi-Urdu have feature-driven *wh*-movement to Spec,vP? *Linguistic Inquiry* 48: 159–172.

- Dayal, Veneeta Srivastav. 1994. Scope marking as indirect wh-dependency. *Natural Language Semantics* 2: 137–170.
- Den Dikken, Marcel. 2007. Phase extension: Contours of a theory of the role of head movement in phrasal extraction. *Theoretical Linguistics* 33: 1–41.
- Den Dikken, Marcel. 2017. Overtly marked *wh*-paths. In: *The Wiley Blackwell Companion to Syntax: Second Edition, Vol. IV*, ed. by Martin Everaert and Henk van Riemsdijk, Hoboken, NJ: Wiley, pp. 2844–2884.
- Dryer, Matthew. 2013. Order of subject, object and verb. In: *The World Atlas of Language Structures Online*, ed. by Matthew Dryer and Martin Haspelmath, Leipzig: Max Planck Institute for Evolutionary Anthropology, available at: <https://wals.info/chapter/81>.
- Epstein, Samuel, Erich Groat, Ruriko Kawashima and Hisatsugu Kitahara. 1998. *A Derivational Approach to Syntactic Relations*. Oxford: Oxford University Press.
- Epstein, Samuel and T. Daniel Seely. 2002. Rule applications as cycles in a level-free syntax. In: *Derivation and Explanation in the Minimalist Program*, ed. by Samuel Epstein and T. Daniel Seely, Oxford: Blackwell, pp. 65–89.
- Erlewine, Michael Yoshitaka. 2016. Review of *Minimalist Interfaces: Evidence from Indonesian and Javanese* by Yosuke Sato. *Oceanic Linguistics* 55: 298–306.
- Erlewine, Michael Yoshitaka. 2018. Extraction and licensing in Toba Batak. *Language* 94: 662–697.
- Erlewine, Michael Yoshitaka, Theodore Levin and Coppe van Urk. 2017. Ergativity and Austronesian-type voice systems. In: *The Oxford Handbook of Ergativity*, ed. by Jessica Coon, Diane Massam and Lisa deMena Travis, Oxford: Oxford University Press, pp. 373–396.
- Fanselow, Gisbert. 2004. The MLC and derivational economy. In: *Minimality Effects in Syntax*, ed. by Arthur Stepanov, Gisbert Fanselow and Ralf Vogel, Berlin: de Gruyter, pp. 73–123.
- Fortin, Catherine. 2006. Reconciling *meng*- and NP movement in Indonesian. In: *Proceedings of the 32nd Annual Meeting of the Berkeley Linguistics Society (BLS 32)*, ed. by Zhenya Antić, Charles B. Chang, Clare S. Sandy and Maziar Toosarvandani, Berkeley, CA: Berkeley Linguistics Society, pp. 47–58.
- Fortin, Catherine. 2007. Indonesian sluicing and verb phrase ellipsis: Description and explanation in a Minimalist framework. Ph.D. dissertation, University of Michigan.
- Fox, Danny. 1999. Reconstruction, binding theory, and the interpretation of chains. *Linguistic Inquiry* 30: 157–196.
- Gallego, Ángel. 2017. Remark on the EPP in labeling theory: Evidence from Romance. *Syntax* 20: 384–399.
- Gallego, Ángel and Juan Uriagereka. 2007a. Conditions and sub-extraction. In: *Coreference, Modality, and Focus*, ed. by Luis Eguren and Olga Fernández-Soriano, Amsterdam: John Benjamins, pp. 45–70.
- Gallego, Ángel and Juan Uriagereka. 2007b. Sub-extraction from subjects: A phase theory account. In: *Romance Linguistics 2006*, ed. by José Camacho, Nydia Flores-Ferrán, Lilitiana Sánchez, Viviane Déprez and María José Cabrera, Amsterdam: John Benjamins, pp. 155–168.

- Georgi, Doreen. 2014. Opaque interactions of Merge and Agree: On the nature and order of elementary operations. Ph.D. dissertation, Universität Leipzig.
- Giannakidou, Anastasia and Hedde Zeijlstra. 2017. The landscape of negative dependencies: Negative concord and n-words. In: *The Wiley Blackwell Companion to Syntax, 2nd edition, Vol. IV*, ed. by Martin Everaert and Henk van Riemsdijk, Hoboken, NJ: Wiley, pp. 2099–2136.
- Gibson, Edward and Tessa Warren. 2004. Reading-time evidence for intermediate linguistic structure in long-distance dependencies. *Syntax* 7: 55–78.
- Giorgi, Alessandra and Fabio Pianesi. 1996. Verb movement in Italian and syncretic categories. *Probus* 8: 137–160.
- Giorgi, Alessandra and Fabio Pianesi. 1997. *Tense and Aspect: From Semantics to Morphosyntax*. Oxford: Oxford University Press.
- Grano, Thomas and Howard Lasnik. 2018. How to neutralize a finite clause boundary: Phase theory and the grammar of bound pronouns. *Linguistic Inquiry* 49: 465–499.
- Grohmann, Kleanthes. 1997. German superiority. *Groninger Arbeiten zur Germanistischen Linguistik* 40: 97–107.
- Guilfoyle, Eithne, Henrietta Hung and Lisa Travis. 1992. Spec of IP and Spec of VP: Two subjects in Austronesian languages. *Natural Language and Linguistic Theory* 10: 375–414.
- Harbert, Wayne and Maher Bahloul. 2002. Postverbal subjects and the theory of agreement. In: *Themes in Arabic and Hebrew Syntax*, ed. by Jamal Ouhalla and Ur Shlonsky, Dordrecht: Kluwer, pp. 45–70.
- Harizanov, Boris. 2019. Head movement to specifier positions. *Glossa* 4: 140.
- Harizanov, Boris and Vera Gribanova. 2019. Whither head movement? *Natural Language and Linguistic Theory* 37: 461–522.
- Harley, Heidi. 2017. The “bundling” hypothesis and the disparate functions of little v. In: *The Verbal Domain*, ed. by Roberta D’Alessandro, Irene Franco and Ángel Gallego, Oxford: Oxford University Press, pp. 3–28.
- Henry, Alison. 2012. Phase edges, quantifier float and the nature of (micro-)variation. *Iberia* 4: 23–39.
- Höhle, Tilman. 2000. The W-... W-construction: Appositive or scope indicating? In: *Wh-Scope Marking*, ed. by Uli Lutz, Gereon Müller and Arnim von Stechow, Amsterdam: John Benjamins, pp. 249–270.
- Hsu, Brian. 2016. Syntax-prosody interactions in the clausal domain: Head movement and coalescence. Ph.D. dissertation, University of Southern California, Los Angeles, CA.
- Hsu, Brian. to appear. Coalescence: A unification of bundling operations in syntax, *Linguistic Inquiry*.
- Janke, Vikki and Ad Neeleman. 2012. Ascending and descending VPs in English. *Linguistic Inquiry* 43: 151–190.
- Jeoung, Helen. 2018. Optional elements in Indonesian morphosyntax. Ph.D. dissertation, University of Pennsylvania, Philadelphia, PA.
- Kayne, Richards. 1989. Facets of Romance past participle agreement. In: *Dialect Variation and the Theory of Grammar*, ed. by Paola Benincà, Dordrecht: Foris, pp. 85–103.

- Keenan, Edward and Bernard Comrie. 1977. Noun Phrase Accessibility and Universal Grammar. *Linguistic Inquiry* 8: 63–99.
- Keenan, Edward and Bernard Comrie. 1979. Data on the Noun Phrase Accessibility Hierarchy. *Language* 55: 333–351.
- Keine, Stefan. 2020a. Locality domains in syntax: Evidence from sentence processing. *Syntax* 23: 105–151.
- Keine, Stefan. 2020b. *Probes and Their Horizons*. Cambridge, MA: MIT Press.
- Koopman, Hilda. 1996. The Spec Head configuration. In: *Syntax at Sunset*, ed. by Edward Garrett and Felicia Lee, University of California, Los Angeles: Department of Linguistics, UCLA Working papers in syntax and semantics, Vol. 1, pp. 37–64.
- Koopman, Hilda. 1999. The internal and external distribution of pronominal DPs. In: *Beyond Principles and Parameters: Essays in Memory of Osvaldo Jaeggli*, ed. by Kyle Johnson and Ian Roberts, Dordrecht: Kluwer, pp. 91–132.
- Koopman, Hilda. 2000. *The Syntax of Specifiers and Heads*. London: Routledge.
- Koopman, Hilda. 2006. Agreement configurations: In defense of “Spec head”. In: *Agreement Systems*, ed. by Cedric Boeckx, Amsterdam: John Benjamins, pp. 159–199.
- Korsah, Sampson and Andrew Murphy. 2020. Tonal reflexes of movement in Asante Twi. *Natural Language and Linguistic Theory* 38: 827–885.
- Kotek, Hadas. 2014. Composing questions. Ph.D. dissertation, MIT, Cambridge, MA.
- Kotek, Hadas. 2019. *Composing Questions*. Cambridge, MA: MIT Press.
- Lahiri, Utpal. 2002. On the proper treatment of “expletive *Wh*” in Hindi. *Lingua* 112: 501–540.
- Landau, Idan. 2007. EPP extensions. *Linguistic Inquiry* 38: 485–523.
- Larson, Richard. 1988. On the double object construction. *Linguistic Inquiry* 19: 335–391.
- Larson, Richard. 2004. Sentence-final adverbs and “scope”. In: *Proceedings of the 34th North East Linguistic Society (NELS 34)*, ed. by Keir Moulton and Matthew Wolf, Amherst, MA: GLSA, pp. 23–43.
- Lechner, Winfried. 2003. Phrase structure paradoxes, movement and ellipsis. In: *The Interfaces: Deriving and Interpreting Omitted Structures*, ed. by Kerstin Schwabe and Susanne Winkler, Amsterdam: John Benjamins, pp. 177–204.
- Legate, Julie Anne. 2003. Some interface properties of the phase. *Linguistic Inquiry* 34: 506–516.
- Legate, Julie Anne. 2011. Under-inheritance, Handout of talk at NELS 42, available at: <https://www.ling.upenn.edu/~jlegate/nels11h.pdf>.
- Legate, Julie Anne. 2014. *Voice and v: Lessons from Acehnese*. Cambridge, MA: MIT Press.
- Levin, Theodore. 2015. Licensing without Case. Ph.D. dissertation, MIT, Cambridge, MA.
- Macdonald, Roderick Ross and Soenjono Darjowidjojo. 1967. *A Student’s Reference Grammar of Modern Formal Indonesian*. Washington, D.C.: Georgetown University Press.
- Mahajan, Anoop. 1989. Agreement and agreement phrases. In: *Functional Heads and Clause Structure*, ed. by Itziar Laka and Anoop Mahajan, Cambridge, MA: MIT, pp. 217–252, MIT Working Papers in Linguistics 10.
- Manetta, Emily. 2010. *Wh*-expletives in Hindi-Urdu: The vP phase. *Linguistic Inquiry* 41: 1–34.
- Manetta, Emily. 2011. *Peripheries in Kashmiri and Hindi-Urdu: The Syntax of Discourse-Driven Movement*. Amsterdam: John Benjamins.

- Manetta, Emily. 2012. Reconsidering rightward scrambling: Postverbal constituents in Hindi-Urdu. *Linguistic Inquiry* 43: 43–74.
- Manzini, Rita. 1994. Locality, Minimalism, and parasitic gaps. *Linguistic Inquiry* 25: 481–508.
- Marfo, Charles O.. 2005a. Akan focus and topic constructions and the prosody-syntax interface. *Journal of West African Languages* 32: 45–59.
- Marfo, Charles Ofosu. 2005b. Aspects of Akan grammar and the phonology-syntax interface. Ph.D. dissertation, University of Hong Kong.
- Martinović, Martina. 2015. Feature geometry and head-splitting: Evidence from the morphosyntax of the Wolof clausal periphery. Ph.D. dissertation, University of Chicago, Chicago, IL.
- Martinović, Martina. 2017. Wolof *wh*-movement at the syntax-morphology interface. *Natural Language and Linguistic Theory* 35: 205–256.
- Martinović, Martina. 2019. Feature geometry and head-splitting in the wolof clausal periphery, Ms., McGill University.
- McCloskey, James. 1979. *Transformational Syntax and Model Theoretic Semantics: A Case Study in Modern Irish*. Dordrecht: Reidel.
- McCloskey, James. 2000. Quantifier float and *wh*-movement in an Irish English. *Linguistic Inquiry* 31: 57–84.
- McCloskey, James. 2001. The morphosyntax of *wh*-extraction in Irish. *Journal of Linguistics* 37: 67–100.
- McCloskey, James. 2002. Resumptives, successive cyclicity, and the locality of operations. In: *Derivation and Explanation in the Minimalist Program*, ed. by Samuel Epstein and T. Daniel Seely, Oxford: Blackwell, pp. 184–226.
- McGinnis, Martha. 1998. Locality in A-movement. Ph.D. dissertation, MIT, Cambridge, MA.
- Müller, Gereon. 2004. Phrase impenetrability and *wh*-intervention. In: *Minimality Effects in Syntax*, ed. by Arthur Stepanov, Gisbert Fanselow and Ralf Vogel, Berlin: Mouton de Gruyter, pp. 289–325.
- Müller, Gereon. 2010. On deriving CED effects from the PIC. *Linguistic Inquiry* 41: 35–82.
- Müller, Gereon. 2011. *Constraints on Displacement: A Phase-Based Approach*. Amsterdam: John Benjamins.
- Neeleman, Ad and Fred Weerman. 1999. *Flexible Syntax: A Theory of Case and Arguments*. Dordrecht: Kluwer.
- Nissenbaum, Jonathan. 2000. Investigations of covert phrase movement. Ph.D. dissertation, MIT, Cambridge, MA.
- Pearson, Matthew. 2005. The Malagasy subject/topic as an A'-element. *Natural Language and Linguistic Theory* 23: 381–457.
- Pesetsky, David. 1995. *Zero Syntax: Experiencers and Cascades*. Cambridge, MA: MIT Press.
- Polinsky, Maria. 2003. Non-canonical agreement is canonical. *Transactions of the Philological Society* 101: 279–312.
- Polinsky, Maria and Eric Potsdam. 2001. Long-distance agreement and topic in Tsez. *Natural Language and Linguistic Theory* 19: 583–646.
- Poole, Ethan. 2017. Movement and the semantic type of traces. Ph.D. dissertation, University of Massachusetts, Amherst, MA.

- Poole, Ethan. 2020. Improper case, Ms., University of California, Los Angeles, available at: <https://ling.auf.net/lingbuzz/004148>.
- Pyllkkänen, Liina. 2002. Introducing arguments. Ph.D. dissertation, MIT, Cambridge, MA.
- Pyllkkänen, Liina. 2008. *Introducing Arguments*. Cambridge, MA: MIT Press.
- Rackowski, Andrea and Norvin Richards. 2005. Phase edge and extraction. *Linguistic Inquiry* 36: 565–599.
- Rezac, Milan. 2003. The fine structure of cyclic Agree. *Syntax* 6: 156–182.
- Rezac, Milan. 2004. Elements of cyclic syntax: Agree and Merge. Ph.D. dissertation, University of Toronto, Toronto.
- Richards, Marc. 2004. Object shift and scrambling in North and West Germanic: A case study in symmetrical syntax. Ph.D. dissertation, University of Cambridge, Cambridge, UK.
- Richards, Norvin. 2001. *Movement in Language: Interactions and Architectures*. Oxford: Oxford University Press.
- Richards, Norvin. 2016. *Contiguity Theory*. Cambridge, MA: MIT Press.
- Rivero, María Luisa. 1994. Clause structure and V-movement in the languages of the Balkans. *Natural Language and Linguistic Theory* 12: 63–120.
- Rizzi, Luigi. 1990. *Relativized Minimality*. Cambridge, MA: MIT Press.
- Rizzi, Luigi. 2006. On the form of chains: Criterial positions and ECP effects. In: *Wh-Movement: Moving On*, ed. by Lisa Cheng and Norbert Corver, Cambridge, MA: MIT Press, pp. 97–133.
- Rizzi, Luigi. 2010. On some properties of criterial freezing. In: *The Complementizer Phase: Subjects and Operators*, ed. by E. Phoevos Panagiotidis, Oxford: Oxford University Press, pp. 17–32.
- Rizzi, Luigi. 2015. Cartography, criteria, and labeling. In: *Beyond Functional Sequence: The Cartography of Syntactic Structures, Vol. 10*, ed. by Uri Shlonsky, Oxford: Oxford University Press, pp. 314–338.
- Roberts, Ian. 1991. Excorporation and minimality. *Linguistic Inquiry* 22: 209–218.
- Roberts, Ian. 1994. Two types of head movement in Romance. In: *Verb Movement*, ed. by David Lightfoot and Norbert Hornstein, Cambridge: Cambridge University Press, pp. 207–242.
- Roberts, Ian. 2010. *Agreement and Head Movement: Clitics, Incorporation, and Defective Goals*. Cambridge, MA: MIT Press.
- Saddy, Douglas. 1991. WH scope mechanisms in Bahasa Indonesia. In: *More Papers on Wh-Movement*, ed. by Lisa Cheng and Hamida Demirdache, Cambridge, MA: MITWPL, pp. 183–218, MIT Working Papers in Linguistics 15.
- Saito, Mamoru and Naoki Fukui. 1998. Order in phrase structure and movement. *Linguistic Inquiry* 29: 439–474.
- Sato, Yosuke. 2012. Successive cyclicity at the syntax-morphology interface: Evidence from Standard Indonesian and Kendal Javanese. *Studia Linguistica* 66: 32–57.
- Sauerland, Uli. 2003. Intermediate adjunction with A-movement. *Linguistic Inquiry* 34: 308–314.
- Sheehan, Michelle. 2013. Some implications of a copy theory of labeling. *Syntax* 16: 362–396.
- Soh, Hooi Ling. 1998. Certain restrictions on A-bar movement in Malay. In: *Recent Papers in Austronesian Linguistics. Proceedings of the Third and Fourth Meetings of the Austronesian Formal Linguistics Association (AFLA)*, ed. by Matthew Pearson, Los Angeles, CA: UCLA

- Department of Linguistics, pp. 295–308.
- Soh, Hooi Ling and Hiroki Nomoto. 2009. Progressive aspect, the verbal prefix *men-*, and stative sentences in Malay. *Oceanic Linguistics* 48: 148–171.
- Soh, Hooi Ling and Hiroki Nomoto. 2011. The Malay verbal prefix *men-* and the unergative/unaccusative distinction. *Journal of East Asian Linguistics* : 77–106.
- Sportiche, Dominique. 1988. A theory of floating quantifiers and its corollaries for constituent structure. *Linguistic Inquiry* 19: 425–450.
- Sportiche, Dominique. 1996. Clitic constructions. In: *Phrase Structure and the Lexicon*, ed. by Johan Rooryck and Laurie Zaring, Dordrecht: Kluwer, pp. 213–276.
- Starke, Michal. 2001. Move dissolves into Merge: A theory of locality. Ph.D. dissertation, University of Geneva.
- Stowell, Tim. 1981. Origins of phrase structure. Ph.D. dissertation, MIT, Cambridge, MA.
- Takahashi, Daiko. 1993. Movement of wh-phrases in Japanese. *Natural Language and Linguistic Theory* 11: 655–678.
- Takahashi, Daiko. 1994. Minimality of movement. Ph.D. dissertation, University of Connecticut, Storrs.
- Takahashi, Masahiko. 2010. Case, phases, and nominative/accusative conversion in Japanese. *Journal of East Asian Linguistics* 19: 319–355.
- Takahashi, Masahiko. 2011. Some consequences of Case-marking in Japanese. Ph.D. dissertation, University of Connecticut, Storrs.
- Thráinsson, Höskuldur. 1996. On the (non-)universality of functional categories. In: *Minimal Ideas: Syntactic Studies in the Minimalist Framework*, ed. by Werner Abraham, Samuel Epstein, Höskuldur Thráinsson and Jan-Wouter Zwart, Amsterdam: John Benjamins, pp. 253–281.
- Travis, Lisa. 1984. Parameters and effects of word order variation. Ph.D. dissertation, MIT, Cambridge, MA.
- Tvica, Seid. 2017. *Agreement and Verb Movement: The Rich Agreement Hypothesis from a Typological Perspective*. Utrecht: LOT.
- Van Urk, Coppe. 2015. A uniform syntax for phrasal movement: A case study of Dinka Bor. Ph.D. dissertation, MIT, Cambridge, MA.
- Van Urk, Coppe. 2016. On the distribution of reflexes of successive cyclicity, Handout of talk at the Brussels Conference on Generative Linguistics (BCGL) 9, available at: <http://webspace.qmul.ac.uk/cvanurk/PhaseTheoryTalk.pdf>.
- Van Urk, Coppe. 2018. Pronoun copying in Dinka Bor and the Copy Theory of Movement. *Natural Language and Linguistic Theory* 36: 937–990.
- Van Urk, Coppe. 2020a. How to detect a phase. In: *Recent Developments in Phase Theory*, ed. by Jeroen van Craenenbroeck, Cora Pots and Tanja Temmerman, Berlin: de Gruyter, pp. 89–130.
- Van Urk, Coppe. 2020b. Object licensing in Fijian and the role of adjacency. *Natural Language and Linguistic Theory* 38: 313–364.
- Van Urk, Coppe. 2020c. Successive cyclicity and the syntax of long-distance dependencies. *Annual Review of Linguistics* 6: 111–130.

- Van Urk, Coppe and Norvin Richards. 2015. Two components of long-distance extraction: Successive cyclicity in Dinka. *Linguistic Inquiry* 46: 113–155.
- Wiltschko, Martina. 1997. Scrambling, D-linking and superiority in German. *Groninger Arbeiten zur Germanistischen Linguistik* 41: 107–142.
- Zeijlstra, Hedde. 2004. *Sentential Negation and Negative Concord*. Utrecht: LOT.
- Zeijlstra, Hedde. 2012. There is only one way to agree. *The Linguistic Review* 29: 491–539.